

LC-R0612

For main and standby power supplies
 Expected trickle life:3~5 years at 25°C, approx.5 years at 20°C

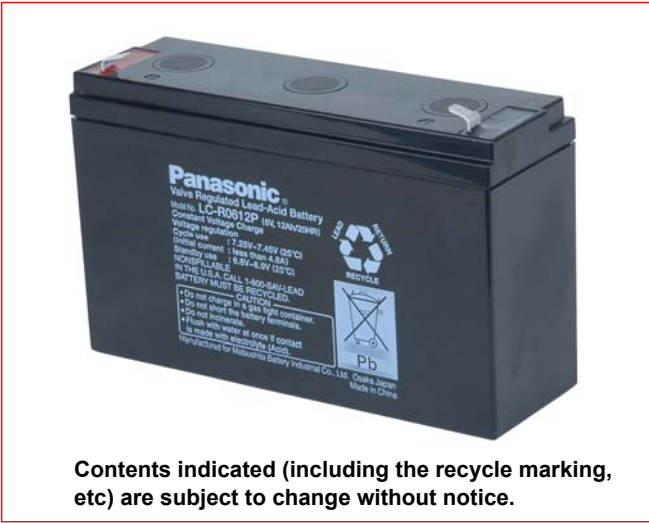

Contents indicated (including the recycle marking, etc) are subject to change without notice.

Dimensions(mm)

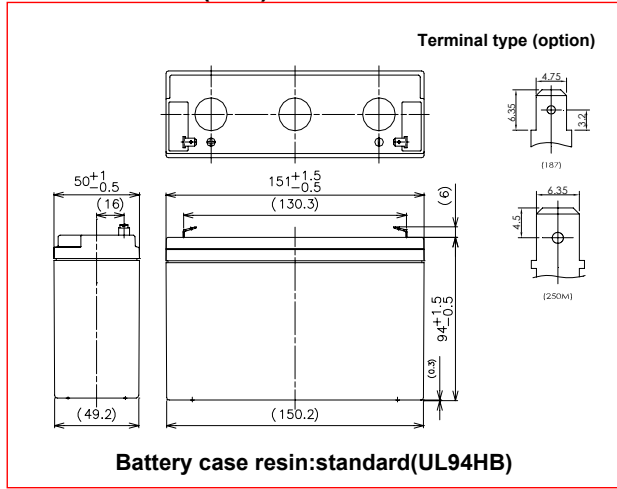

Specification

Nominal Voltage	6V	
Nominal Capacity(20HR)	12Ah	
Dimensions	Length	151 mm
	Width	50 mm
	Height	94 mm
	Total height	100 mm
Approx. Mass	1.95 kg	
Terminal	Faston 187 & 250M	

Characteristics

Capacity (25 °C)	20 hour rate	12Ah
	10 hour rate	11.3Ah
	5 hour rate	10.4Ah
	1 hour rate	8.1Ah
Internal Resistance	Fully charged battery (25 °C)	8 mΩ
	Temperature Dependency of Capacity (20 hour rate)	
	40 °C	102%
	25 °C	100%
	0 °C	85%
	-15 °C	65%
Self Discharge (25 °C)	After 3 months	91%
	After 6 months	82%
	After 12 months	64%

Duration of discharge vs. discharge current

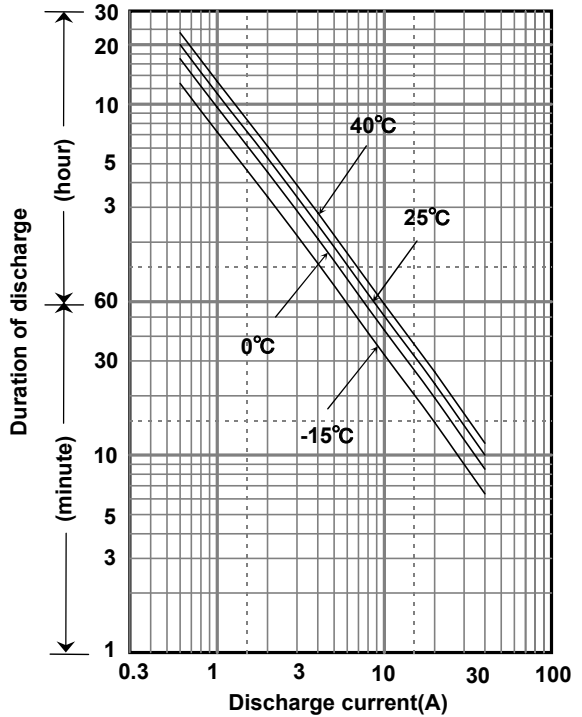

Watt Table(25°C)

Cut-off V	3min	5min	10min	15min	20min	30min	45min	1h	1.5h	2h	3h	4h	5h	6h	10h	20h	24h
4.8V	340	279	192	149	124	91.3	68.7	52.4	35.1	27.2	19.0	14.4	12.0	10.9	6.66	3.61	3.01
4.95V	325	269	186	144	121	88.3	67.5	51.8	35.0	27.1	18.9	14.4	12.0	10.9	6.66	3.61	3.01
5.1V	304	253	181	141	118	88.3	66.9	51.2	34.5	26.9	18.7	14.4	12.0	10.8	6.60	3.61	3.01
5.25V	278	237	171	136	115	86.0	66.3	50.1	34.2	26.6	18.4	14.3	12.0	10.8	6.60	3.60	3.00
5.4V	247	217	161	131	113	83.1	61.6	48.9	33.1	26.0	18.1	14.2	11.9	10.7	6.54	3.59	2.99

Ampere Table(25°C)

Cut-off V	3min	5min	10min	15min	20min	30min	45min	1h	1.5h	2h	3h	4h	5h	6h	10h	20h	24h
4.8V	61.1	50.1	34.3	25.9	21.3	15.6	11.7	8.90	5.95	4.60	3.20	2.41	2.01	1.81	1.11	0.602	0.502
4.95V	58.4	48.2	33.3	25.0	20.8	15.1	11.5	8.80	5.92	4.58	3.18	2.41	2.01	1.81	1.11	0.602	0.502
5.1V	54.6	45.4	32.4	24.5	20.3	15.1	11.4	8.70	5.85	4.55	3.15	2.41	2.00	1.80	1.10	0.601	0.501
5.25V	50.0	42.6	30.6	23.6	19.9	14.7	11.3	8.50	5.80	4.50	3.10	2.40	2.00	1.80	1.10	0.600	0.500
5.4V	44.5	38.9	28.7	22.7	19.4	14.2	10.5	8.30	5.60	4.40	3.05	2.38	1.99	1.79	1.09	0.598	0.498

■ Charging Method (25°C)

Cycle use	Control voltage:7.25-7.45V;Initial current:4.8A or smaller
Trickle use	Control voltage:6.8-6.9V;Initial current:1.8A or smaller

■ Cut off voltage

Discharge current	0.6A-2.4A	2.4A-6.0A	6.0A-12A	12A-24A	24A-36A
Cut off voltage(V)	5.25	5.1	4.95	4.65	4.35

■ Influence of Temperature on Trickle life

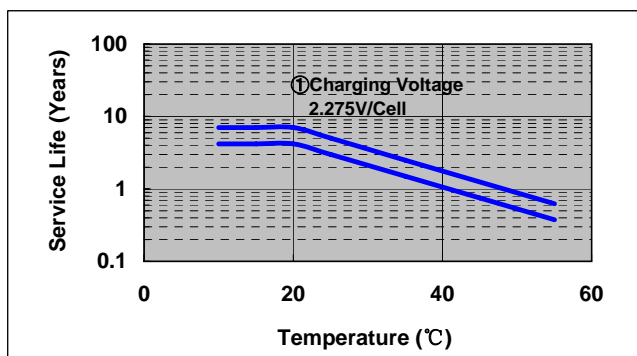

■ Cycle life vs. Depth of discharge

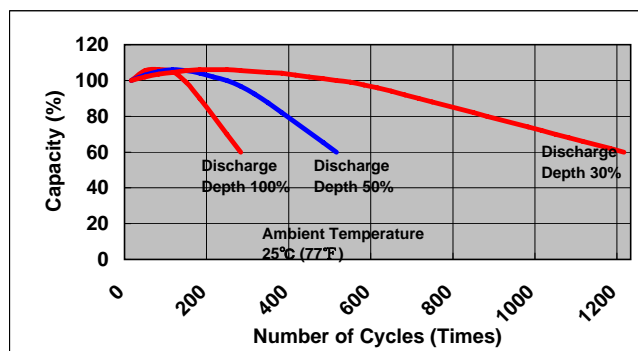

■ Residual capacity test result

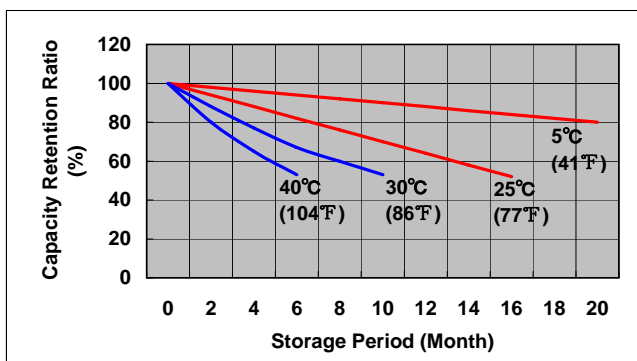

■ Discharge capacity by temperature and by discharge current

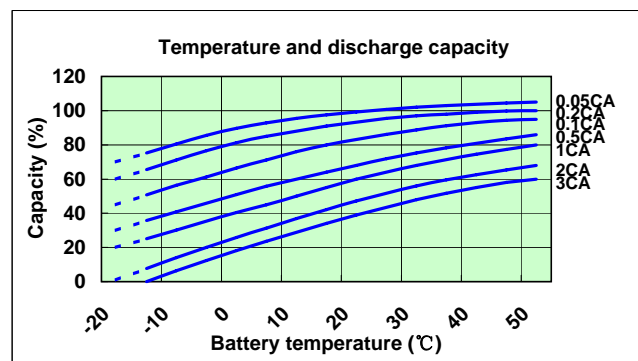

■ Constant-voltage constant-current charge characteristics for Trickle use

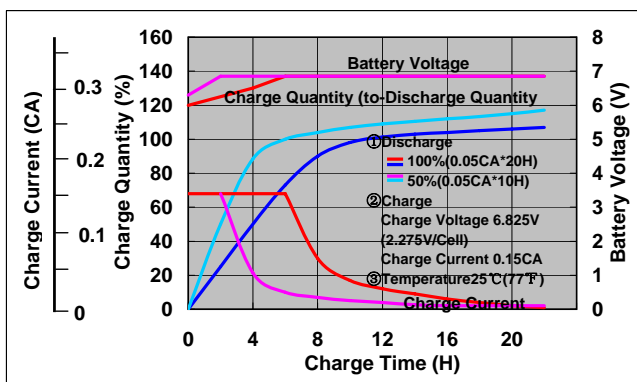

■ Constant-voltage constant-current charge characteristics for Cycle use

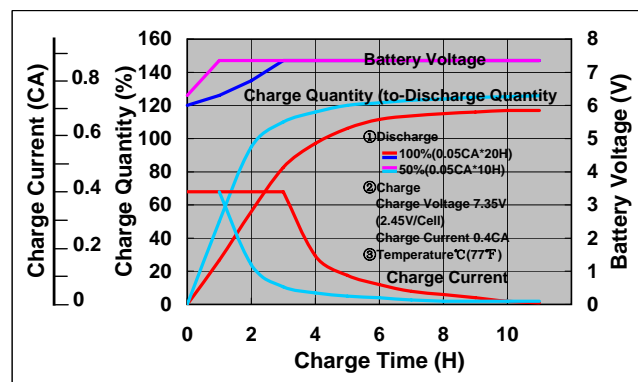

■ Discharge characteristics(25°C)

