

Primary Lithium Cells

Lithium Manganese
Dioxide LiMnO_2

Sales Program and
Technical Handbook



CONTENT

1.	GENERAL INFORMATION.....	3–4
1.1	Constructions of Lithium Cells	5–6
1.2	Characteristics and Applications.....	7
1.3	Applications	8–9
1.4	Selection Guide	10
2.	CR PRIMARY LITHIUM BUTTON CELLS.....	11
2.1	Types – Technical Data.....	12–22
2.2	Assemblies	23–26
3.	CR HIGH CAPACITY PRIMARY LITHIUM CYLINDRICAL CELLS	27
3.1	Types – Technical Data	28–31
3.2	Assemblies	32–33
4.	CR HIGH POWER PRIMARY LITHIUM CYLINDRICAL CELLS	34
4.1	Types – Technical Data	35–41
4.2	Assemblies	42
5.	GENERAL DESIGN CHARACTERISTICS	43
5.1	Safety Tests	46
5.2	Safety Guidelines	47
5.3	OEM – Application Check List.....	48–50

Subject to change without further notice. No responsibility for the correctness of this information. For latest technical data please refer to our data sheets which you will find on our website www.varta-microbattery.com.

© by VARTA Microbattery GmbH

1. GENERAL INFORMATION

1.1	Constructions of Lithium Cells	5-6
1.2	Characteristics and Applications.....	7
1.3	Applications	8-9
1.4	Selection Guide	10

1. GENERAL INFORMATION

The VARTA Microbattery lithium manganese dioxide cell chemistry was one of the first solid cathode cells commercially developed and is still the most widely used system today. These cells offer an excellent shelf life, good high-rate and low-rate capability, a wide operating temperature range and availability in button and cylindrical cell designs. Potential design-in applications for these products are electronic, telecommunication, metering, instrumentation, office and other portable equipment use. Based on the outstanding cell performance and reliability of these products, they have been able to meet and exceed the requirements of our customer base worldwide.

Advantages for VARTA Microbattery LiMnO₂ Cells

- High open circuit and load voltage (above 3.0 volts per cell)
- High energy density (400 Wh/kg and 600 Wh/l)
- High capacity and high rate cell construction
- Operation over a wide temperature range
- Flat discharge profile under low to medium rate applications
- Low self discharge (less than 1% per year at RT)
- Superior shelf life and operational life (Up to 10 years and more)
- UL Recognition
- Ability to provide a variety of laser welded termination tabs for all cell types

Energy Density for Primary Systems

Comparison of different primary battery systems

- A = Lithium
- B = Silver-oxide
- C = Alkaline
- D = Zinc-chloride

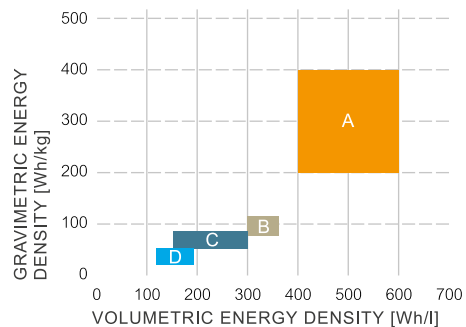

1.1 CONSTRUCTIONS OF LITHIUM CELLS

VARTA Microbattery offers a complete range of primary lithium manganese dioxide cylindrical and button cells for memory backup and portable applications worldwide. The cylindrical cell configurations offer the high-capacity bobbin construction and high-power spirally wound product. The bobbin construction is targeted at low to moderate power requirements, dedicated for applications

requiring up to a 10 years operational life at 20°C. Our spirally wound electrode product offers high-rate discharge capability, with an operational life in excess of 5 years.

For compact and light weight equipment use we have a complete range of high performance primary lithium button cells.

Lithium Cylindrical Batteries

BOBBIN CONSTRUCTION

Schematic construction of a Li/MnO₂ cylindrical cell (CR 1/2 AA).

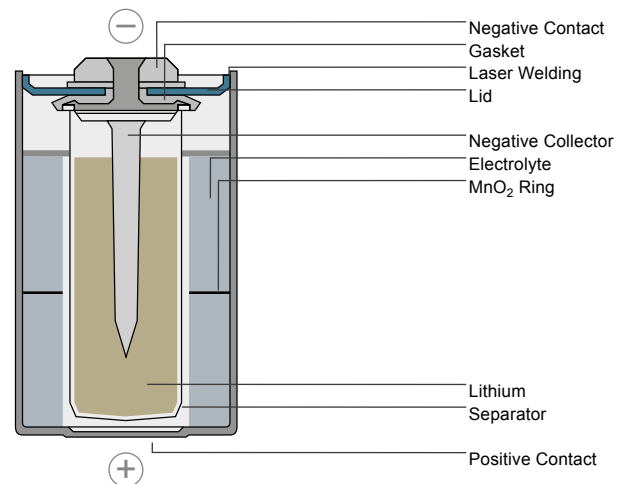

SPIRAL CONSTRUCTION

Schematic construction of a Li/MnO₂ cylindrical cell (CR 2/3 AH).

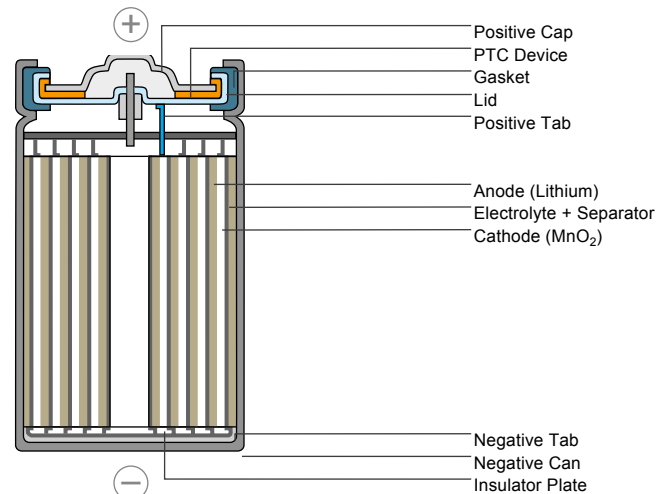

Lithium Button Cells

Schematic construction of a
Li/MnO₂ Button Cell

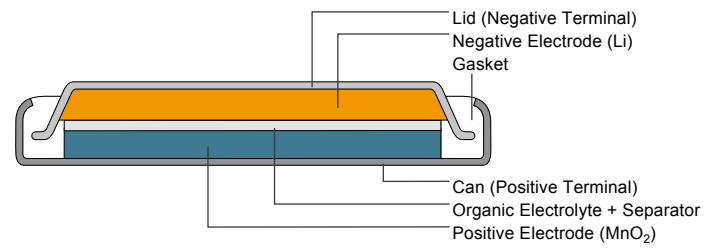

Sealing Technologies

CRIMP-SEALING

CR High Power Cylindrical Cells

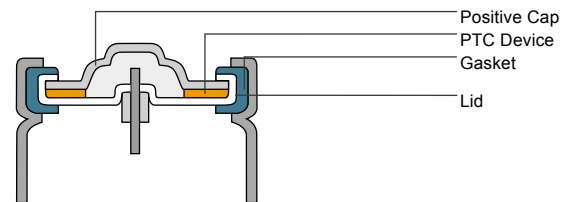

LASER-SEALING

CR High Capacity Cylindrical Cells

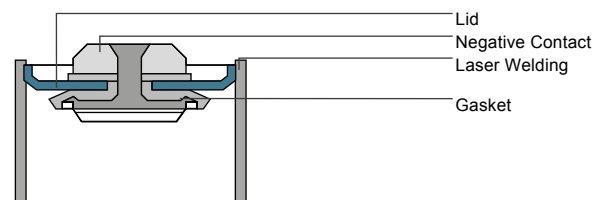

1.2 CHARACTERISTICS AND APPLICATIONS

Main Applications

Both mechanical and electrical properties, together with reliability, ensure that VARTA Microbattery lithium batteries meet the requirements of modern electronics.

They are therefore ideally suited as power sources for the long term supply of microelectronic circuitry.

Main Characteristics

- Long life expectancy and long operational life
- Low self discharge rate
- High energy density
- High cell voltage (3V)
- Wide temperature range
- High operating safety
- High reliability
- Resistance to corrosion with stainless steel case
- No leakage problems with an organic non-corrosive electrolyte

Temperature characteristics

Temperature characteristics of CR 1/2 AA and CR AA cylindrical cells
(Load: 5.6 kΩ CR AA, 12 kΩ CR 1/2 AA)

A = -40°C
B = +80°C
C = +60°C
D = -20°C
E = +23°C

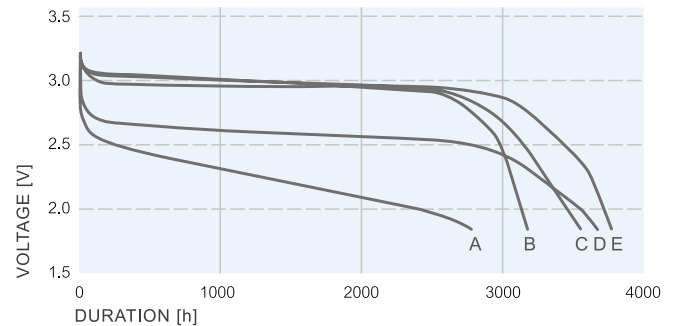

System properties of VARTA Microbattery Lithium Cells

Series	CR Series Cylindrical Cells	CR Series Button Cells
System	Li/MnO ₂	Li/MnO ₂
Gravimetric energy density	250–300 Wh/kg	250–300 Wh/kg
Nominal voltage	3.0 V	3.0 V
Open circuit voltage	3.2 V	3.2 V
Available capacity range	950–2000 mAh	25–560 mAh
Storage life	>10 years ¹⁾	>10 years ¹⁾
Self discharge d=20°C	<1% p.a.	<1% p.a.
Operating temperature	-30 ... +75°C ²⁾	-20 ... +65°C
Maximum temperature range (short term) ³⁾	-40 ... +80°C ⁴⁾	-40 ... +80°C ⁴⁾
Storage temperature ⁵⁾	-55 ... +75°C ²⁾	-55...+70°C

1) CR 2/3 AH, CR 2, (>5 years)

2) CR 2/3 AH (-20 ... +65°C)

3) max. two weeks

4) μA-range

5) Recommended room temperature

1.3 APPLICATIONS

Utility Meters

Electricity Meters, Gas Meters, Water Meters, Calorimeters, Automatic Meter Reading (AMR), Heat Cost Allocator.



Utility Meters

Safety/Security Systems

Door Lockers, Security and Alarm Systems, Smoke and other Sensors and Detectors, Burglar Alarm Systems.



Security Systems

Automotive Electronics

Mileage or Kilometer Counters, Onboard Computers, Electronic Monitoring, Navigational Equipment, Airbag Sensor and Gas Generators, Car radios, Container temperature loggers, Community Traffic Control Systems, Traffic Volume Control, Traffic Chart Recorders, Taximeters.

Asset Tracking

Personal Identification, RF-ID Transponder, Bar Code Reader, Scanner, Goods Tracking, Trailer Identification, Goods Locationing.



Toll Pass



Asset Tracking

Automation

Memory back-up, Intelligent Interfaces, Personal Computers, Intelligent Typewriters, Address Printers, Envelopment Franking Machines, Cash Points, Scales, Copy Machines, Cash Register.



Automation

Vending Machines

Ticket Vending Machines, Newspaper Vending Machines, Cigarette Vending Machines, Sweet Vending Machines, Drink Vending Machines, Parking Meter.



Vending Machines

High End Consumer

Audio and Video Memory back-up and RTC, Video Games, Gambling Machines, SCUBA Diving Meters, Altimeters, Marine Electronics, Ski Bindings, Portable Timing Units for sports events, Pigeon Flight Time Recorders.



High End Consumer

Industrial/Medical Instrumentation

Industrial Clocks, Pulse-/Event-Counters, High Voltage Power Line Fault Detectors, Remote Data Logging and Data Acquisition Systems, Seismic Measurement Equipment, Biotelemetry, Telemetry Equipment, Weather Balloon Transmitters, Automatic Weather Monitoring Stations, Compass Illumination, Caliper Pig for pipeline maintenance, Oscilloscopes, Medical Instruments, Gauges.



Industrial/Medical Instrumentation

1.4 SELECTION GUIDE

To enable battery selection the following is required:

- Discharge current and maximum discharge time
 - capacity
- Operating temperature range
 - self discharge
 - surplus capacity requirement
- Cell size

CAPACITY RETENTION

Capacity retention characteristics of VARTA Microbattery Lithium Cells Cylindrical Cells CR...AA and CR...A

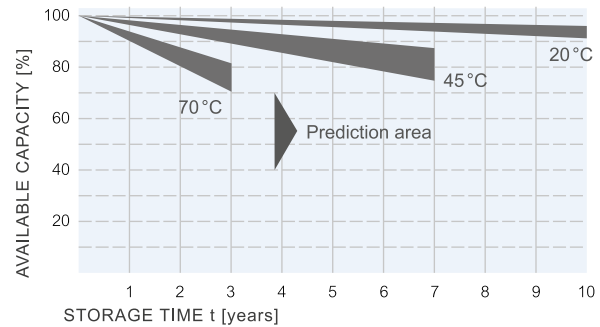

STORAGE BEHAVIOR

Typical storage behaviour at room temperature 21°C of CR 1/2 AA

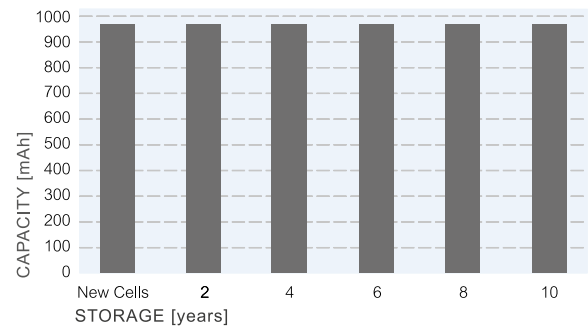

BATTERY SELECTION DIAGRAM

Discharge current/
Operating time

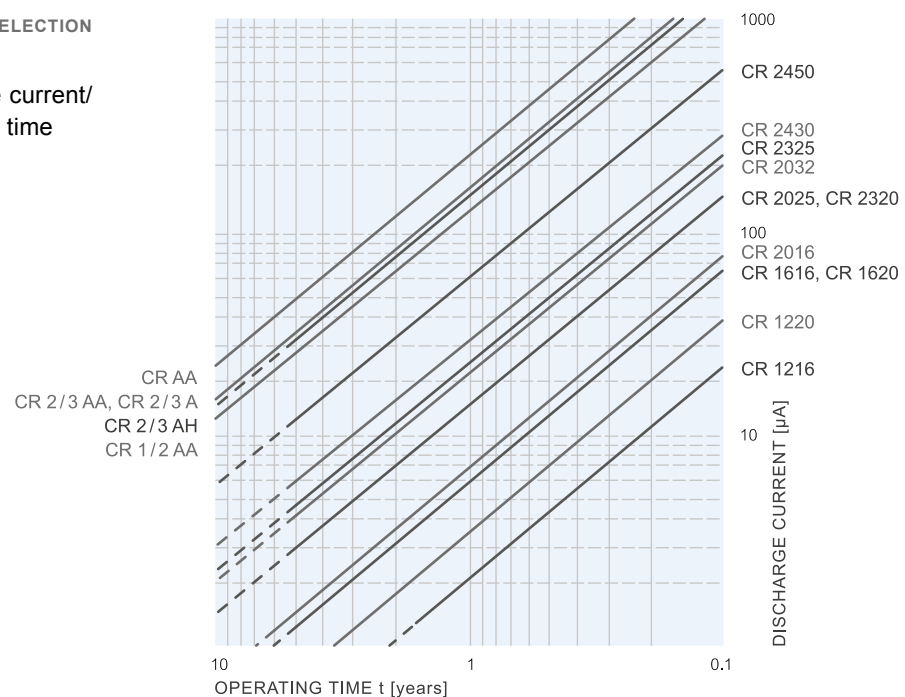

2. CR PRIMARY LITHIUM BUTTON CELLS

2.1	Types – Technical Data.....	12–22
2.2	Assemblies	23–26



2.1 TYPES – TECHNICAL DATA



CR 1216



CR 1616



CR 2016



CR 2025



CR 2032



CR 2450

Type	Order No.	Nominal voltage (V)	Typical capacity ¹⁾ (mAh)	Standard load (kΩ)	Max. discharge current (continuous) (mA)	Max. discharge current (pulse) (mA)	Weight (g)
CR 1/3 N	6131 101 501	3	170	5.6	20	80	3.0
CR 1216	6216 101 501	3	27	39	2	5	0.7
CR 1220	6220 101 501	3	35	39	2	5	0.8
CR 1616	6616 101 501	3	55	39	3	8	1.2
CR 1620	6620 101 501	3	70	20	3	8	1.2
CR 2016	6016 101 501	3	90	15	3	10	1.8
CR 2025	6025 101 501	3	165	10	3	10	2.5
CR 2032	6032 101 501	3	230	5.6	3	10	3.0
CR 2430	6430 101 501	3	300	5.6	3	20	4.0
CR 2450	6450 101 501	3	620	5.6	2	20	6.2

Technical data, CR Primary Lithium Button Cells

¹⁾ Nominal capacity is determined to an end voltage of 2.0 V when the battery is allowed to discharge at standard load level at 20°C

CR 1/3 N

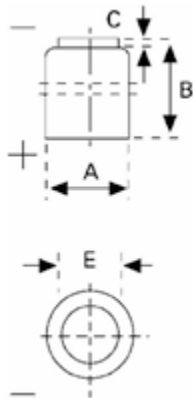

Type Number 6131
 Designation IEC CR 11108
 System Li-Manganese dioxide/
 Organic Electrolyte

UL Recognition MH 13654
 Nominal Voltage 3 V
 Typical Capacity C 170 mAh (Load 5,6 kOhm,
 at 20°C down to 2 V)

Weight (approx.) 3 g
 Volume 1,1 ccm
 Coding TBA

Temperature Ranges min. max.
 Storage -55°C 70°C
 Discharge -20°C 65°C¹

Dimensions min. max.
 Diameter (A) 11,40 11,60
 Height (B) 10,40 10,80
 Shoulder Diameter [L] 7,60 8,00
 Shoulder Height [M] 0,40

Typical Capacities (at 20°C)

Discharge Type	Load	End Voltage: 2,0 V
Continuous 24 h/d, 7 d/w Current [µA]	5600 Ω	Time: 335 h Capacity: 170 mAh Energy: 475 mWh

Performance Data

Temperature Characteristics

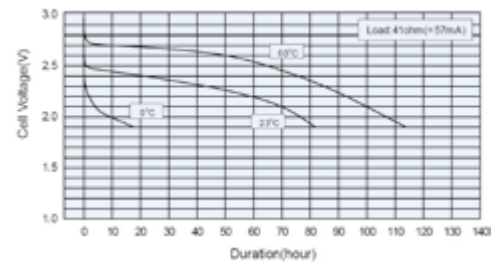

Operating Voltage vs. load resistance

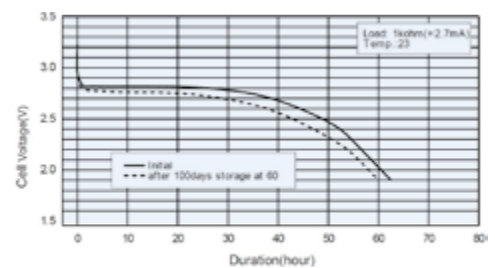

Capacity vs. load resistance

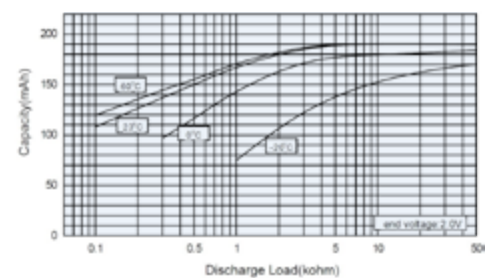

¹ Contact VARTA if the application is intended to be outside the range of -20°C to +65°C.

² depending on environmental condition and energy consumption

- Self-discharge rate < 1%/Y at room temperature
- Storage life > 10 years
- Operating life² > 10 years

CR 1216

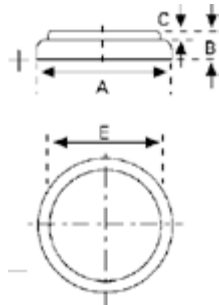

Type Number 6216
 Designation IEC CR 1216
 System Li-Manganese dioxide/
 Organic Electrolyte

UL Recognition MH 13654 (N)
 Nominal Voltage 3 V
 Typical Capacity C 27 mAh (Load 39 kOhm,
 at 20°C down to 2 V)

Weight (approx.) 0,7 g
 Volume 0,17 ccm
 Coding Date of Manufacturing
 Month/Year

Temperature Ranges min. max.
 Storage -55°C 70°C
 Discharge -20°C 70°C¹

Dimensions min. max.
 Diameter (A) 12,20 12,50
 Height (B) 1,40 1,60
 Shoulder Diameter [E] 10,00
 Shoulder Height [C] 0,20

Typical Capacities (at 20°C)

Discharge Type	Load	End Voltage: 2,0 V
Continuous 24 h/d, 7 d/w Current [µA]	39000 Ω	Time: 355 h Capacity: 27 mAh Energy: 77 mWh

Performance Data

Temperature Characteristics

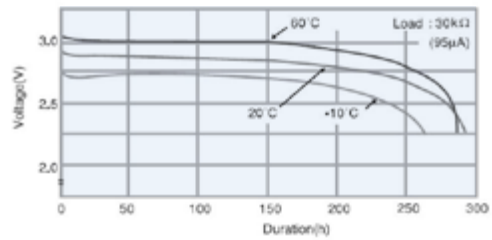

Operating Voltage vs. load resistance*

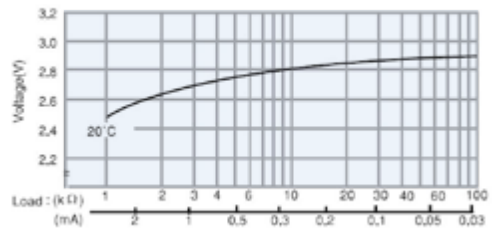

*Discharge depth 50%

Capacity vs. load resistance

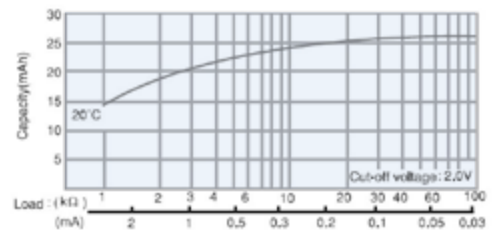

Discharge Characteristics

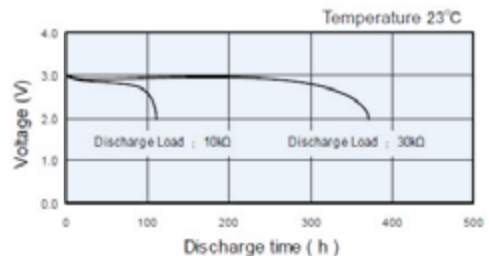

¹ Contact VARTA if the application is intended to be outside the range of -20°C to +70°C.

² depending on environmental condition and energy consumption

- Self-discharge rate < 1%/Y at room temperature
- Storage life > 10 years
- Operating life² > 10 years

CR 1220

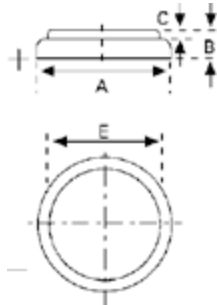

Type Number	6220
Designation IEC	CR 1220
System	Li-Manganese dioxide/ Organic Electrolyte
UL Recognition	MH 13654 (N)
Nominal Voltage	3 V
Typical Capacity C	35 mAh (Load 39 kOhm, at 20°C down to 2 V)
Weight (approx.)	0,8 g
Volume	0,2 ccm
Coding	Date of Manufacturing Month/Year

Temperature Ranges	min.	max.
Storage	-55°C	70°C
Discharge	-20°C	70°C ¹

Dimensions	min.	max.
Diameter (A)	12,20	12,50
Height (B)	1,80	2,00
Shoulder Diameter [E]	10,00	
Shoulder Height [C]	0,30	

Typical Capacities (at 20°C)

Discharge Type	Load	End Voltage: 2,0 V
Continuous 24 h/d, 7 d/w Current [µA]	39000 Ω	Time: 480 h Capacity: 35 mAh Energy: 100 mWh

Performance Data

Temperature Characteristics

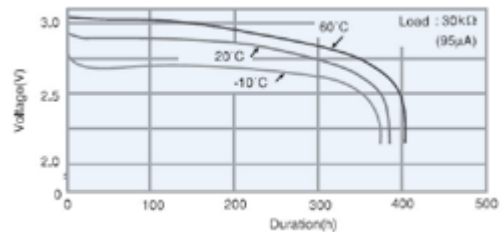

Operating Voltage vs. load resistance*

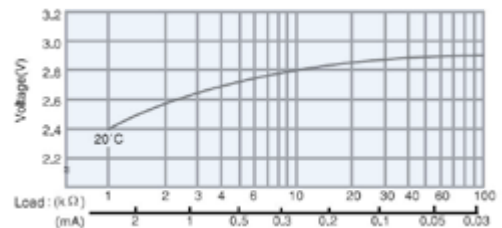

Capacity vs. load resistance

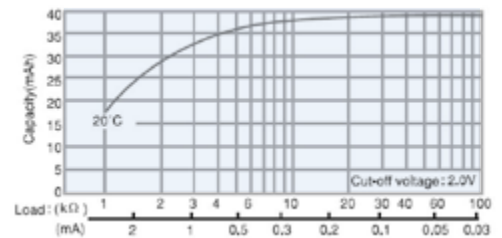

Discharge Characteristics

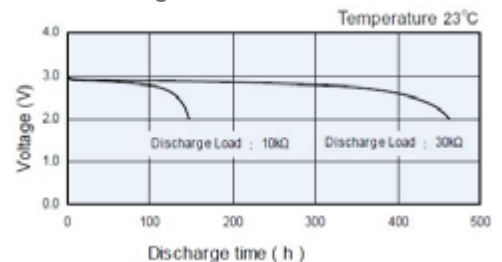

¹ Contact VARTA if the application is intended to be outside the range of -20°C to +70°C.

² depending on environmental condition and energy consumption

- Self-discharge rate < 1%/Y at room temperature
- Storage life > 10 years
- Operating life² > 10 years

CR 1616

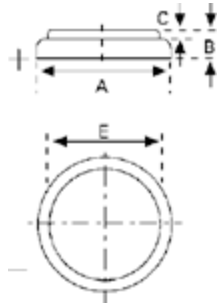

Type Number 6616
 Designation IEC CR 1616
 System Li-Manganese dioxide/
 Organic Electrolyte

UL Recognition MH 13654 (N)
 Nominal Voltage 3 V
 Typical Capacity C 55 mAh (Load 39 kOhm,
 at 20°C down to 2 V)

Weight (approx.) 1,2 g
 Volume 0,3 ccm
 Coding Date of Manufacturing
 Month/Year

Temperature Ranges min. max.
 Storage -55°C 70°C
 Discharge -20°C 70°C¹

Dimensions min. max.
 Diameter (A) 15,70 16,00
 Height (B) 1,40 1,60
 Shoulder Diameter [E] 12,00
 Shoulder Height [C] 0,20

Typical Capacities (at 20°C)

Discharge Type	Load	End Voltage: 2,0 V
Continuous 24 h/d, 7 d/w Current [µA]	39000 Ω	Time: 670 h Capacity: 50 mAh Energy: 142 mWh

Performance Data

Temperature Characteristics

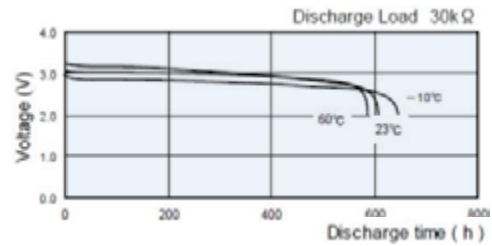

Operating Voltage vs. load resistance*

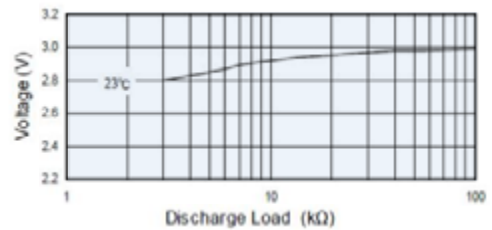

*Discharge depth 40%

Capacity vs. load resistance

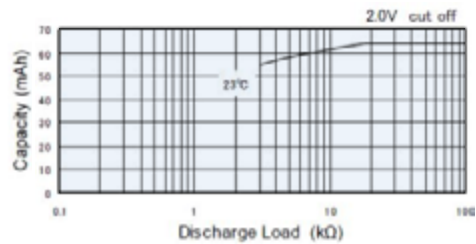

Discharge Characteristics

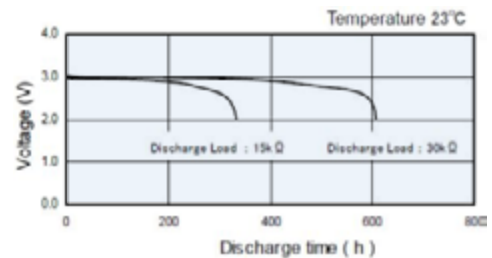

¹ Contact VARTA if the application is intended to be outside the range of -20°C to +70°C.

² depending on environmental condition and energy consumption

- Self-discharge rate < 1%/Y at room temperature
- Storage life > 10 years
- Operating life² > 10 years

CR 1620

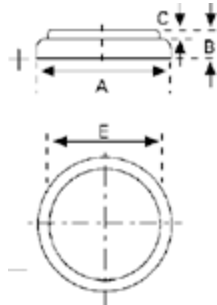

Type Number 6620
 Designation IEC CR 1620
 System Li-Manganese dioxide/
 Organic Electrolyte

UL Recognition MH 13654 (N)
 Nominal Voltage 3 V
 Typical Capacity C 70 mAh (Load 20 kOhm,
 at 20°C down to 2 V)

Weight (approx.) 1,2 g
 Volume 0,4 ccm
 Coding Date of Manufacturing
 Month/Year

Temperature Ranges min. max.
 Storage -55°C 70°C
 Discharge -20°C 70°C¹

Dimensions min. max.
 Diameter (A) 15,70 16,00
 Height (B) 1,80 2,00
 Shoulder Diameter [E] 12,90
 Shoulder Height [C] 0,20

Typical Capacities (at 20°C)

Discharge Type	Load	End Voltage: 2,0 V
Continuous 24 h/d, 7 d/w Current [µA]	20000 Ω	Time: 500 h Capacity: 70 mAh Energy: 200 mWh

Performance Data

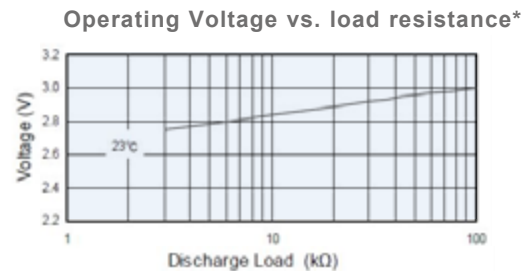
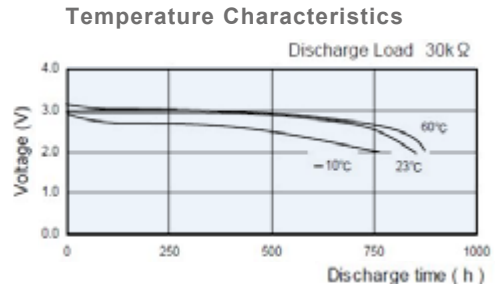

*Discharge depth 40%

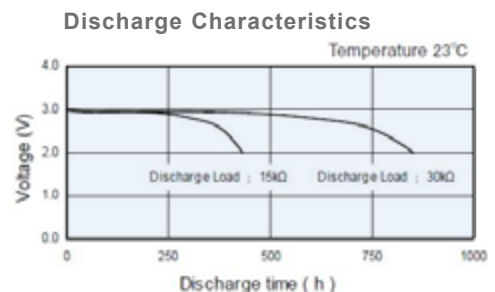
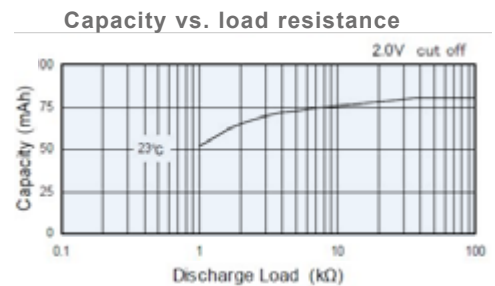

¹ Contact VARTA if the application is intended to be outside the range of -20°C to +70°C.

² depending on environmental condition and energy consumption

- Self-discharge rate < 1%/Y at room temperature
- Storage life > 10 years
- Operating life² > 10 years

CR 2016

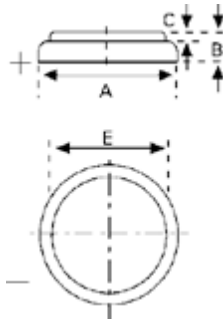

Type Number 6016
 Designation IEC CR 2016
 System Li-Manganese dioxide/
 Organic Electrolyte

UL Recognition MH 13654 (N)
 Nominal Voltage 3 V
 Typical Capacity C 90 mAh (Load 15 kOhm,
 at 20°C down to 2 V)

Weight (approx.) 1,8 g
 Volume 0,5 ccm
 Coding Date of Manufacturing
 Month/Year

Temperature Ranges min. max.
 Storage -55°C 70°C
 Discharge -20°C 70°C¹

Dimensions min. max.
 Diameter (A) 19,70 20,00
 Height (B) 1,40 1,60
 Shoulder Diameter [E] 18,40
 Shoulder Height [C] 0,10

Typical Capacities (at 20°C)

Discharge Type	Load	End Voltage: 2,0 V
Continuous 24 h/d, 7 d/w	15000 Ω	Time: 450 h Capacity: 90 mAh Energy: 270 mWh
	200 μA	

Performance Data

Temperature Characteristics

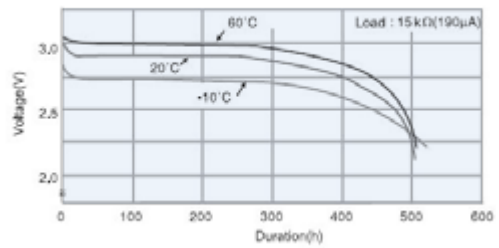

Operating Voltage vs. load resistance*

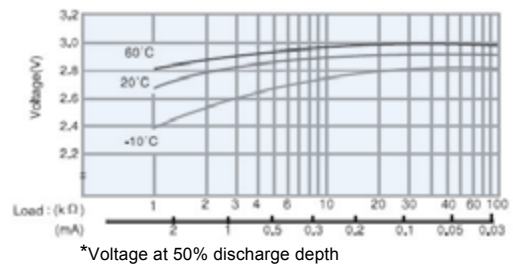

Capacity vs. load resistance

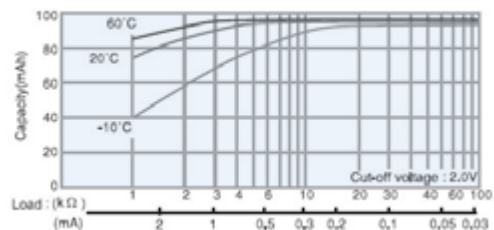

¹ Contact VARTA if the application is intended to be outside the range of -20°C to +70°C.

² depending on environmental condition and energy consumption

- Self-discharge rate < 1%/Y at room temperature
- Storage life > 10 years
- Operating life² > 10 years

CR 2025

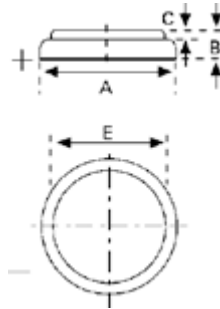

Type Number 6025
 Designation IEC CR 2025
 System Li-Manganese dioxide/
 Organic Electrolyte

UL Recognition MH 13654 (N)
 Nominal Voltage 3 V
 Typical Capacity C 165 mAh (Load 10 kOhm,
 at 20°C down to 2 V)

Weight (approx.) 2,5 g
 Volume 0,75 ccm
 Coding Date of Manufacturing
 Month/Year

Temperature Ranges min. max.
 Storage -55°C 70°C
 Discharge -20°C 70°C¹

Dimensions min. max.
 Diameter (A) 19,70 20,00
 Height (B) 2,20 2,50
 Shoulder Diameter [E] 18,30
 Shoulder Height [C] 0,20

Typical Capacities (at 20°C)

Discharge Type	Load	End Voltage: 2,0 V
Continuous 24 h/d, 7 d/w Current [µA]	10000 Ω	Time: 580 h Capacity: 165 mAh Energy: 475 mWh

Performance Data

Temperature Characteristics

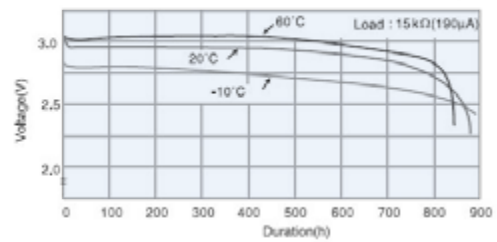

Operating Voltage vs. load resistance*

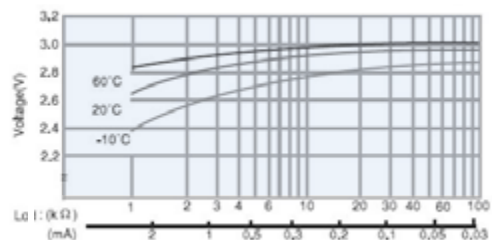

*Voltage at 50% discharge depth

Capacity vs. load resistance

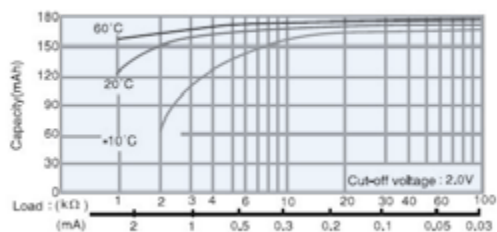

¹ Contact VARTA if the application is intended to be outside the range of -20°C to +70°C.

² depending on environmental condition and energy consumption

- Self-discharge rate < 1%/Y at room temperature
- Storage life > 10 years
- Operating life² > 10 years

CR 2032

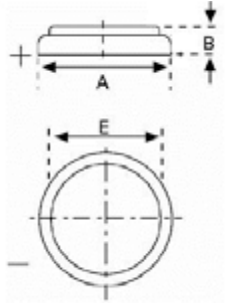

Type Number 6032
 Designation IEC CR 2032
 System Li-Manganese dioxide/
 Organic Electrolyte

UL Recognition MH 13654 (N)
 Nominal Voltage 3 V
 Typical Capacity C 230 mAh (Load 5,6 kOhm
 at 20°C down to 2 V)

Weight (approx.) 3 g
 Volume 0,95 ccm
 Coding Date of Manufacturing
 Month/Year

Temperature Ranges min. max.
 Storage -55°C 70°C
 Discharge -20°C 70°C¹

Dimensions min. max.
 Diameter (A) 19,70 20,00
 Height (B) 2,90 3,20
 Shoulder Diameter [E] 16,00

Typical Capacities (at 20°C)

Discharge Type	Load	End Voltage: 2,0 V
Continuous 24 h/d, 7 d/w Current [µA]	5600 Ω	Time: 460 h Capacity: 230 mAh Energy: 645 mWh

Performance Data

Temperature Characteristics

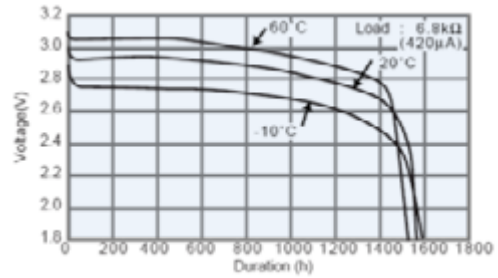

Operating Voltage vs. load resistance*

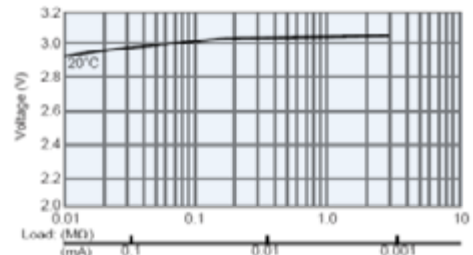

*Discharge depth 40%

Capacity vs. load resistance

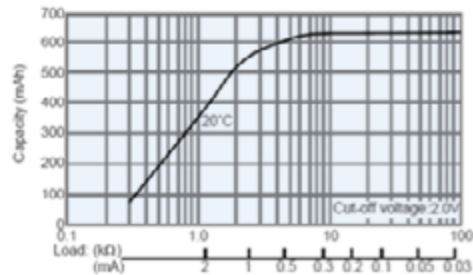

¹ Contact VARTA if the application is intended to be outside the range of -20°C to +70°C.

² depending on environmental condition and energy consumption

- Self-discharge rate < 1%/Y at room temperature
- Storage life > 10 years
- Operating life² > 10 years

CR 2430

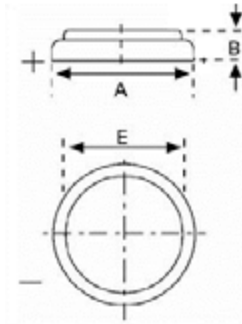

Type Number 6430
 Designation IEC CR 2430
 System Li-Manganese dioxide/
 Organic Electrolyte

UL Recognition MH 13654 (N)
 Nominal Voltage 3 V
 Typical Capacity C 300 mAh (Load 5,6 kOhm,
 at 20°C down to 2 V)

Weight (approx.) 4 g
 Volume 1,3 ccm
 Coding Date of Manufacturing
 Month/Year

Temperature Ranges min. max.
 Storage -55°C 70°C
 Discharge -20°C 70°C¹

Dimensions min. max.
 Diameter (A) 24,20 24,50
 Height (B) 2,70 3,00
 Shoulder Diameter [E] 16,30 16,70

Typical Capacities (at 20°C)

Discharge Type	Load	End Voltage: 2,0 V
Continuous 24 h/d, 7 d/w Current [µA]	5600 Ω	Time: 600 h Capacity: 300 mAh Energy: 840 mWh

Performance Data

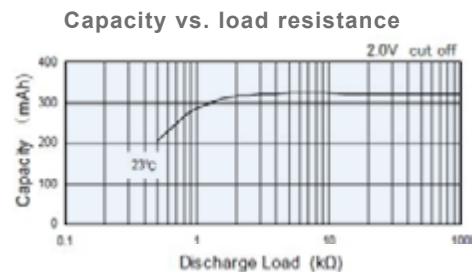
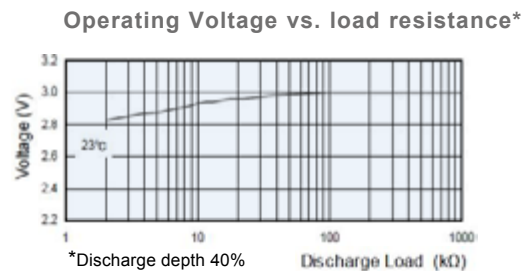
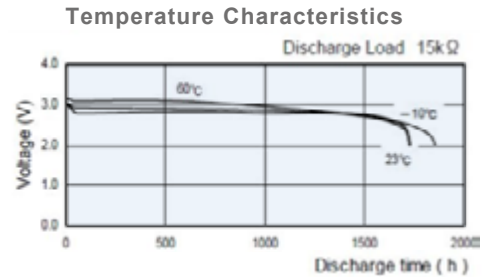

¹ Contact VARTA if the application is intended to be outside the range of -20°C to +70°C.

² depending on environmental condition and energy consumption

- Self-discharge rate < 1%/Y at room temperature
- Storage life > 10 years
- Operating life² > 10 years

CR 2450

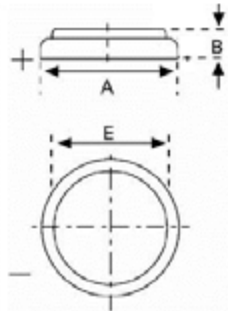

Type Number 6450
 Designation IEC CR 2450
 System Li-Manganese dioxide/
 Organic Electrolyte

UL Recognition MH 13654 (N)
 Nominal Voltage 3 V
 Typical Capacity C 620 mAh (Load 5,6 kOhm
 at 20°C down to 2 V)

Weight (approx.) 6,2 g
 Volume 2,3 ccm
 Coding Date of Manufacturing
 Month/Year

Temperature Ranges min. max.
 Storage -55°C 70°C
 Discharge -20°C 70°C¹

Dimensions min. max.
 Diameter (A) 24,20 24,70
 Height (B) 4,60 5,00
 Shoulder Diameter [E] 21,00

Typical Capacities (at 20°C)

Discharge Type	Load	End Voltage: 2,0 V
Continuous 24 h/d, 7 d/w	5600 Ω	Time: 1250 h Capacity: 620 mAh Energy: 1730 mWh

Performance Data

Temperature Characteristics

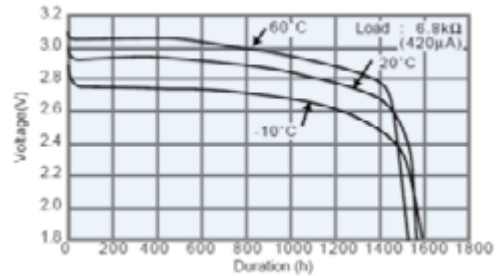

Operating Voltage vs. load resistance*

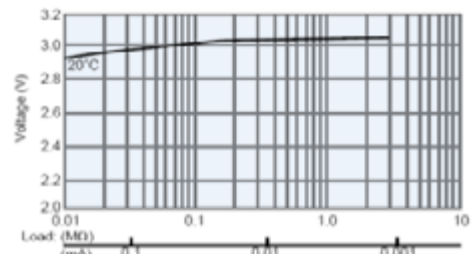

*Discharge depth 40%

Capacity vs. load resistance

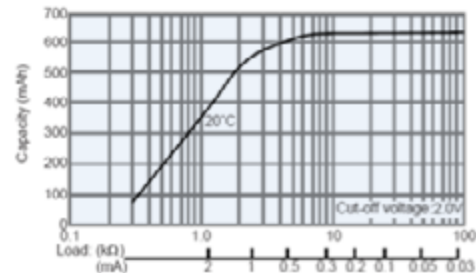

¹ Contact VARTA if the application is intended to be outside the range of -20°C to +70°C.

² depending on environmental condition and energy consumption

- Self-discharge rate < 1%/Y at room temperature
- Storage life > 10 years
- Operating life² > 10 years

2.2 ASSEMBLIES

CR 1/3 N

Type	Order No.	A	B	C	D	E	F	G	H	I	K	L	Fig.No.	Remarks
CR 1/3 N	6131 101 501	11.6	10.8	0.4	7.8	-	-	-	-	-	-	-	1	-
CR 1/3 N PC PCB	6131 201 501	13.0	1.0	10.0	1.0 ±0.5	11.5 ±0.5	12.0 ±0.5	-	1.0 ±0.5	3.0	-	-	3	tag 0.25 mm
CR 1/3 N BE STO	6131 301 501	-	-	-	-	11.5	12.0	-	-	-	19.0	4.0	2	tag 0.25 mm 180°

Tag material: nickel plated sheet-steel. SLF: tip tinned.

Custom made assemblies are available on request for large volume.

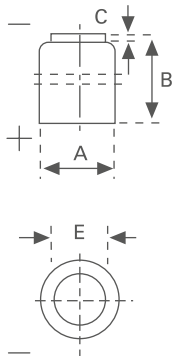

FIG. 1

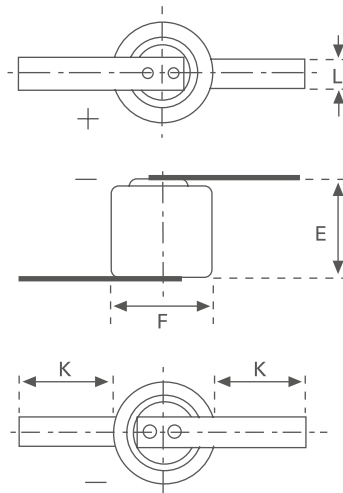

FIG. 2 LF

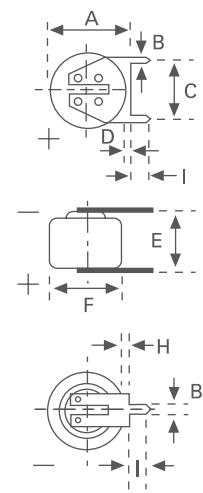

FIG. 3 SLF

CR Button

Type	Order No.	A	B	C	D	E	F	G	H	I	K	L	Fig. No.	Remarks
CR 1216	6216 101 501	12.5	1.6	0.2	-	10.0	-	-	-	-	-	-	4	
CR 1220	6220 101 501	12.5	2.0	0.3	-	10.0	-	-	-	-	-	-	4	
CR 1616	6616 101 501	16.0	1.6	0.2	-	12.0	-	-	-	-	-	-	4	
CR 1620	6620 101 501	16.0	2.0	0.02	-	12.9	-	-	-	-	-	-	4	
CR 2016	6016 101 501	20.0	1.6	0.1	-	-	-	-	-	-	-	-	4	
CR 2016 SC PCBD	6016 201 501	21.3	1.0	10.0 ±0.15	1.0 ±0.3	2.1 ±0.5	20.3 ±0.15	-	1.0 ±0.3	4.5	-	-	5	tag 0.25 mm
CR 2016 SC STO	6016 301 501	20.0	-	-	-	1.9	20.0	-	-	-	10.0	4.0	6	tag 0.15 mm
CR 2016 BE PCBD	6016 401 501	20.0	1.0	10.0	9.1	1.6	17.8	7.3	10.0	4.5	11.4	-	7	tag 0.15 mm
CR 2016 FM S STO	6016 301 012	20.5	3.5	1.8	3.0	2.2	-	-	-	-	-	-	-	

Tag material: nickel plated sheet-steel. SLF: tip tinned.

Custom made assemblies are available on request for large volume.

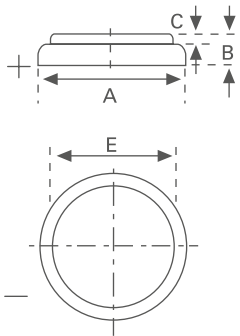

FIG. 4

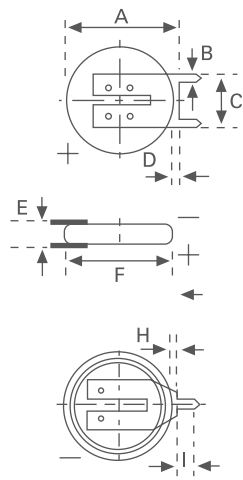

FIG. 5 SLF

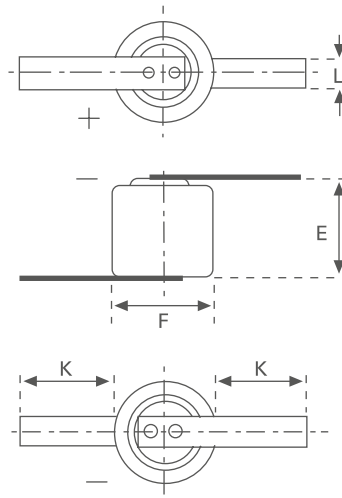

FIG. 6 LF

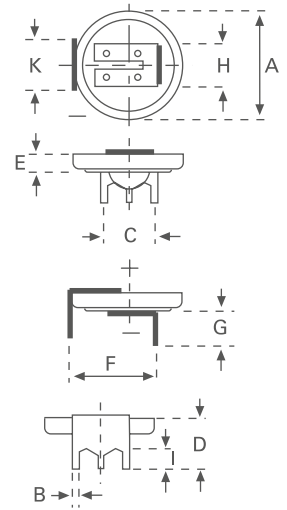

FIG. 7 PCB 3

CR Button

Type	Order No.	A	B	C	D	E	F	G	H	I	K	L	Fig. No.	Remarks
CR 2025	6025 101 501	20.0	2.5	0.2	-	-	-	-	-	-	-	-	8	-
CR 2025 ST	6025 201 501	21.3	1.0	10.0 ±0.2	1.0 ±0.3	3.0 ±0.5	20.3 ±0.15	-	1.0 ±0.3	4.5	-	-	9	tag 0.25 mm
CR 2025 SC STO	6025 301 501	20.0	-	-	-	2.8	20.3	-	-	-	10.0	4.0	10	tag 0.15 mm
CR 2025 BE PCBD	6025 401 501	20.0	1.0	10.0	10.0	2.8	17.8	7.3	10.0	4.5	11.4	-	11	tag 0.15 mm
CR 2032	6032 101 501	20.0	3.2	0.02	-	16.5	-	-	-	-	-	-	8	-
CR 2032 SC PCBD	6032 201 501	21.5	1.0	10.0	1.0 ±0.3	4.2	20.3	-	1.0	4.5	-	-	9	tag 0.25 mm
CR 2032 SC STO	6032 301 501	-	-	-	-	3.2	20.3	-	-	-	10.0	4.0	10	tag 0.15 mm
CR 2032 PCBD	6032 401 501	20.0	1.0	10.0	11.0	3.2	17.8	7.5	10.0	4.5	11.4	-	11	tag 0.25 mm
CR 2032 BE PCBS	6032 701 501	20.0	1.0	-	11.0	3.2	17.8	7.3	10.0	4.5	10.0	-	12	tag 0.20 mm
CR 2032 S WC ¹⁾	6032 101 013	20.7	-	-	-	5.5	30.0	-	-	-	96.0	2.0	13	tag 0.20 mm ²⁾
CR 2032 S STO	6032 101 012	20.0	7.0	2.8	5.0	3.8	-	-	-	-	-	-	14	-

Tag material: nickel plated sheet-steel. SLF: tip tinned.

¹⁾ using Molex 51021-03 connector (Other wire connectors and wire length are available on request.) ²⁾ in shrink sleeve with wire and connector

Custom made assemblies are available on request for large volume.

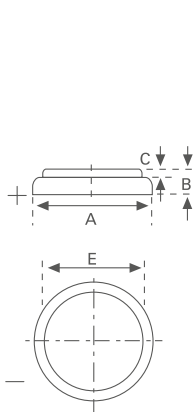

FIG. 8

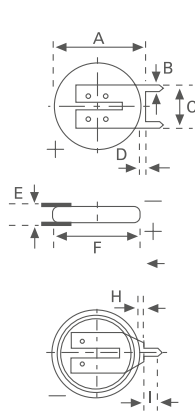

FIG. 9 SLF

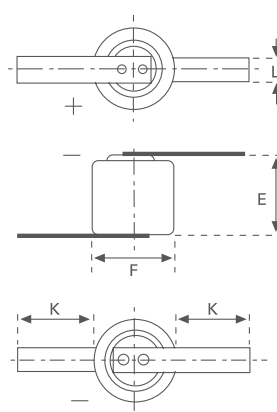

FIG. 10 LF

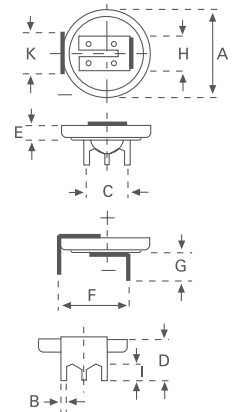

FIG. 11 PCB3

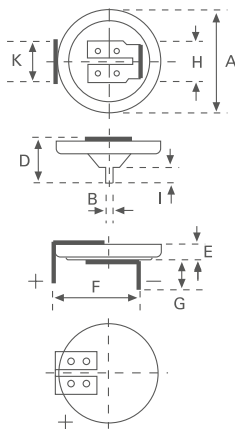

FIG. 12 PCB 2

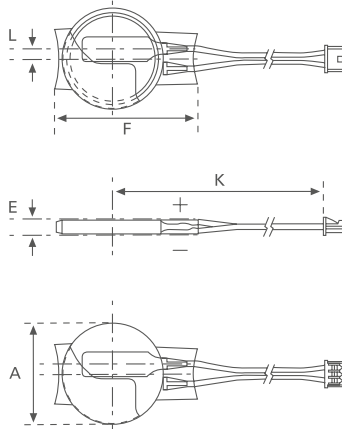

FIG. 13 WC

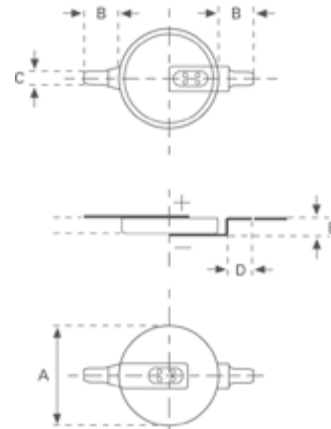

FIG. 14 SMT

CR Button

Type	Order No.	A	B	C	D	E	F	G	H	I	K	L	Fig. No.	Remarks
CR 2430	6430 101 501	24.5	3.0	0.3	-	20.0	-	-	-	-	-	-	15	-
CR 2430 SLF	6430 201 501	25.6	1.0	10.0	1.0	4.0	25.0	-	1.0	4.5	-	-	16	tag 0.25 mm
CR 2430 LF	6430 301 501	-	-	-	-	3.2	25.0	-	-	-	10.0	4.0	17	tag 0.15 mm
CR 2430 PCB 3	6430 401 501	24.5	1.0	10.0	11.0	3.0	17.8	7.5	10.0	4.5	11.4	-	18	tag 0.25 mm
CR 2430 PCB 2	6430 701 501	24.5	1.0	-	11.0	3.0	20.0	7.5	10.0	4.5	11.4	-	19	tag 0.20 mm
CR 2430 SMT	6430 301 012	24.5	5.2	4.0	5.0	3.3	-	-	-	-	-	-	20	-
CR 2450	6450 101 501	24.7	5.0	0.5	-	21.8	-	-	-	-	-	-	15	-
CR 2450 SLF	6450 201 501	25.6	1.0	10.0	1.0	6.0	25.0	-	1.0	4.5	-	-	16	tag 0.25 mm
CR 2450 PCB 3	6450 401 501	24.5	1.0	10.0	13.2	5.0	17.8	7.5	10.0	4.5	11.4	-	18	tag 0.25 mm
CR 2450 PCB 2	6450 701 501	24.7	1.0	-	12.7	5.0	17.8	7.5	10.0	4.5	11.4	-	19	tag 0.20 mm
CR 2450 SMT	6450 301 013	24.5	4.5	2.8	3.5	5.3	-	-	-	-	-	-	20	-

Tag material: nickel plated sheet-steel. SLF: tip tinned.

¹⁾ using Molex 51021-03 connector (Other wire connectors and wire length are available on request.) ²⁾ in shrink sleeve with wire and connector
 Custom made assemblies are available on request for large volume.

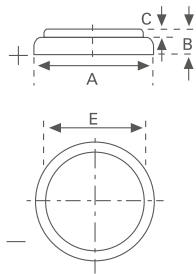

FIG. 15

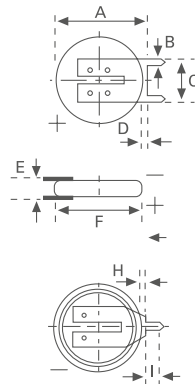

FIG. 16 SLF

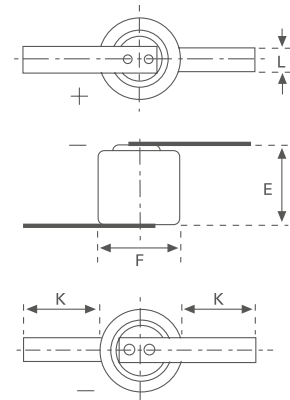

FIG. 17 LF

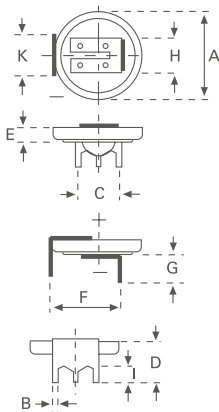

FIG. 18 PCB 3

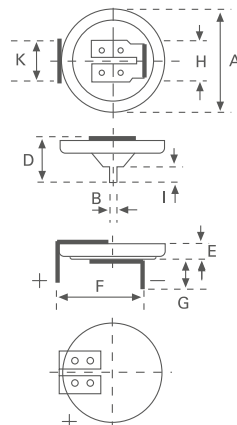

FIG. 19 PCB 2

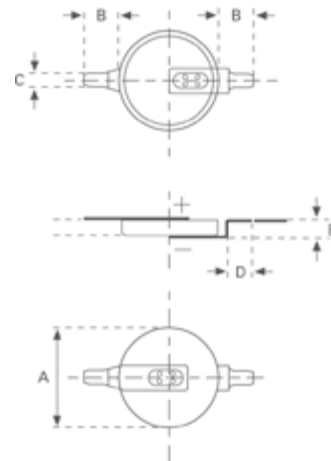
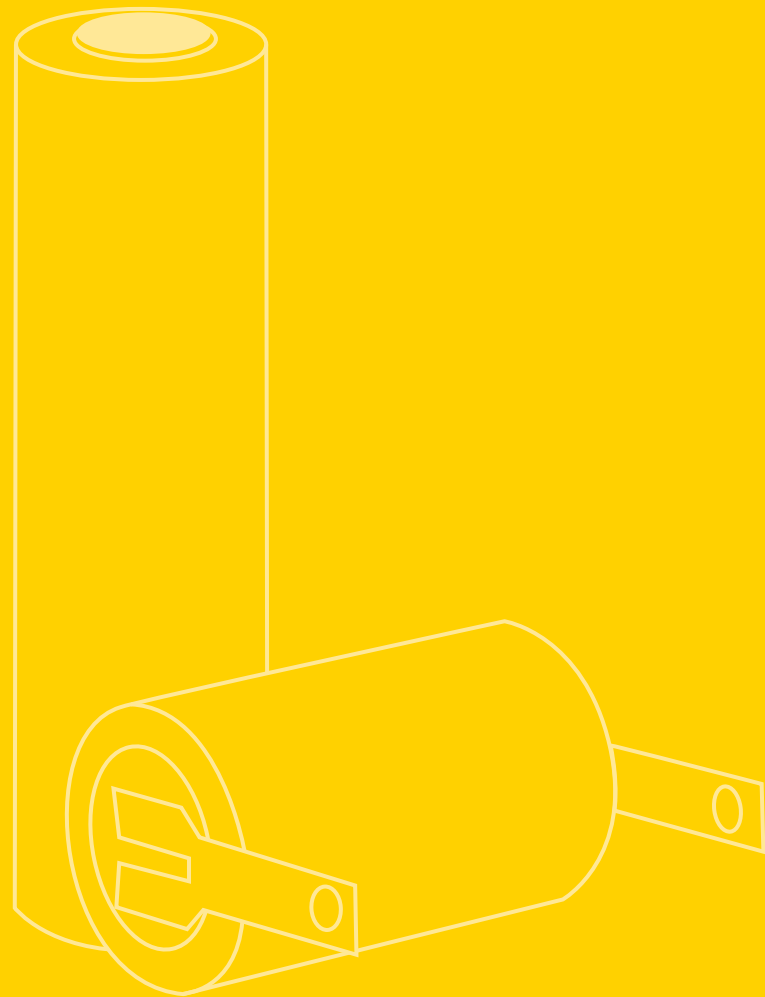

FIG. 20 SMT

3. CR HIGH CAPACITY PRIMARY LITHIUM CYLINDRICAL CELLS



3.1	Types – Technical Data	28–31
3.2	Assemblies	32–33



3.1 TYPES – TECHNICAL DATA

Type	Order No.	Nominal voltage (V)	Nominal capacity at 20°C, down to 2.0 V, load (mAh)	Max. continuous discharge current (mA)	Weight (g)
CR 1/2 AA	6127 101 301	3	950 mAh–5.6 kΩ	5	11.5
CR 2/3 AA	6237 101 301	3	1350 mAh–1.0 kΩ	10	15.0
CR AA	6117 101 301	3	2000 mAh–1.0 kΩ	15	21.5

Technical data, CR High Capacity Primary Lithium Cylindrical Cells



CR 1/2 AA



CR 2/3 AA



CR AA

CR 1/2 AA

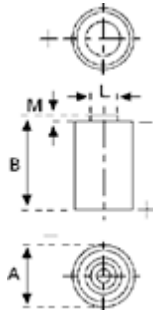

Type Number	6127
Designation IEC	-
System	Li-Manganese dioxide/ Organic Electrolyte
UL Recognition	MH 13654 (N)
Nominal Voltage	3 V
Typical Capacity C	950 mAh (Load 5,6 kOhm, at 20°C down to 2 V)
Weight (approx.)	11,5 g
Volume	5 ccm
Coding	Date of Manufacturing Month/Year

Temperature Ranges	min.	max.
Storage	-55°C	70°C
Discharge	-30°C	75°C ¹

Dimensions	min.	max.
Diameter (A)	14,15	14,45
Height (B)	25,09	25,30
Shoulder Diameter [L]	7,00	
Shoulder Height [M]	0,90	

Typical Capacities (at 20°C)

Discharge Type	Load	End Voltage: 2,0 V
Continuous 24 h/d, 7 d/w	5600 Ω	Time: 1860 h Capacity: 950 mAh Energy: 2700 mWh
Continuous 24 h/d, 7 d/w	2000 Ω	Time: 670 h Capacity: 930 mAh Energy: 2600 mWh
Continuous 24 h/d, 7 d/w	1000 Ω	Time: 335 h Capacity: 900 mAh Energy: 2400 mWh
Constant current	50 μA	Capacity: 1000 mAh

Performance Data

Temperature Characteristics*

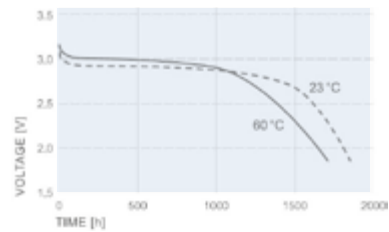

*Discharge Load 5,6 kΩ

Operating Voltage vs. load resistance*

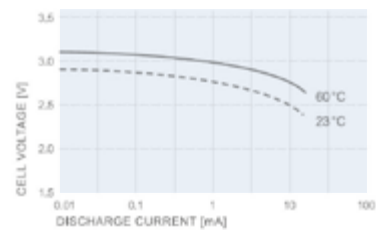

*Discharge depth 50%

Capacity vs. load resistance

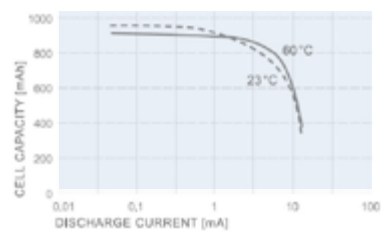

Discharge Characteristics*

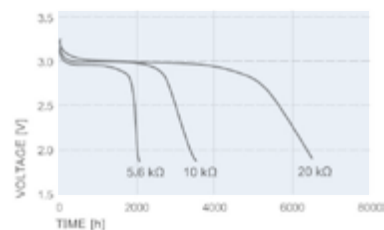

*at room temperature 21°C

¹ Contact VARTA if the application is intended to be outside the range of -30°C to +75°C.

² depending on environmental condition and energy consumption

- Self-discharge rate < 1%/Y at room temperature
- Storage life > 10 years
- Operating life² > 10 years

CR 2/3 AA

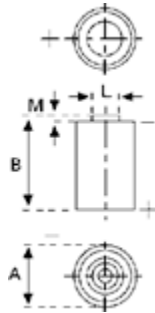

Type Number 6237
 Designation IEC -
 System Li-Manganese dioxide/
 Organic Electrolyte

UL Recognition MH 13654 (N)
 Nominal Voltage 3 V
 Typical Capacity C 1350 mAh (Load 1,0 kOhm,
 at 20°C down to 2 V)

Weight (approx.) 15 g
 Volume 5,6 ccm
 Coding Date of Manufacturing
 Month/Year

Temperature Ranges min. max.
 Storage -55°C 70°C
 Discharge -30°C 75°C¹

Dimensions min. max.
 Diameter (A) 14,45 14,75
 Height (B) 33,10 33,00
 Shoulder Diameter [L] 7,00
 Shoulder Height [M] 0,60

Typical Capacities (at 20°C)

Discharge Type	Load	End Voltage: 2,0 V
Continuous 24 h/d, 7 d/w	1000 Ω	Time: 500 h Capacity: 1350 mAh Energy: 3600 mWh

Performance Data

Temperature Characteristics*

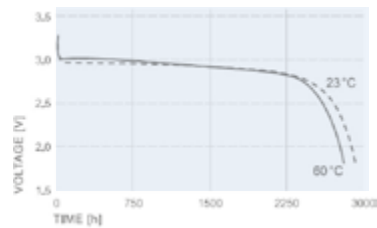

*Discharge Load 5,6 kΩ

Operating Voltage vs. load resistance*

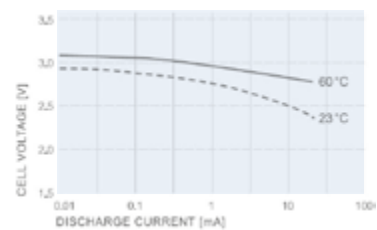

*Discharge depth 50%

Capacity vs. load resistance

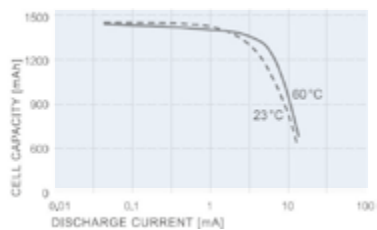

Discharge Characteristics*

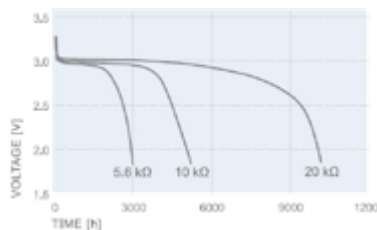

*at room temperature 21°C

¹ Contact VARTA if the application is intended to be outside the range of -30°C to +75°C.

² depending on environmental condition and energy consumption

- Self-discharge rate < 1%/Y at room temperature
- Storage life > 10 years
- Operating life² > 10 years

CR AA

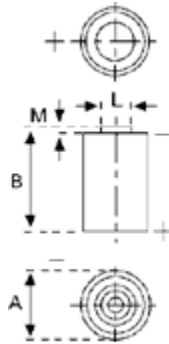

Type Number	6117
Designation IEC	-
System	Li-Manganese dioxide/ Organic Electrolyte
UL Recognition	MH 13654 (N)
Nominal Voltage	3 V
Typical Capacity C	2000 mAh (Load 1,0 kOhm, at 20°C down to 2 V)
Weight (approx.)	21,5 g
Volume	8,5 ccm
Coding	Date of Manufacturing Month/Year

Temperature Ranges	min.	max.
Storage	-55°C	70°C
Discharge	-30°C	75°C ¹

Dimensions	min.	max.
Diameter (A)	14,45	14,75
Height (B)	49,50	50,50
Shoulder Diameter [L]	7,00	
Shoulder Height [M]	0,60	

Typical Capacities (at 20°C)

Discharge Type	Load	End Voltage: 2,0 V
Continuous 24 h/d, 7 d/w	1000 Ω	Time: 745 h Capacity: 2000 mAh Energy: 5600 mWh
Continuous 24 h/d, 7 d/w	620 Ω	Time: 430 h Capacity: 1850 mAh Energy: 5000 mWh

Performance Data

Temperature Characteristics*

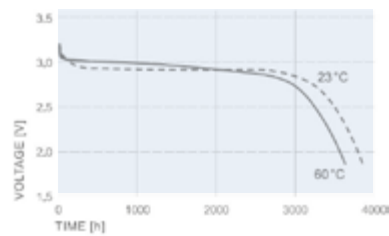

*Discharge Load 5,6 kΩ

Operating Voltage vs. load resistance*

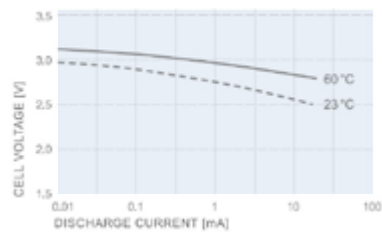

*Discharge depth 50%

Capacity vs. load resistance

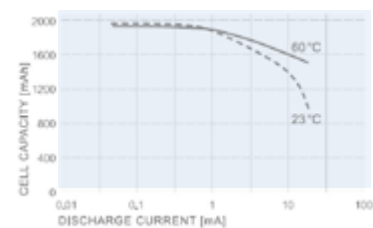

Discharge Characteristics*

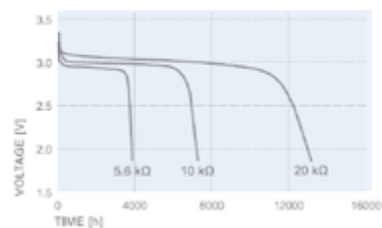

*at room temperature 21°C

¹ Contact VARTA if the application is intended to be outside the range of -30°C to +75°C.

² depending on environmental condition and energy consumption

- Self-discharge rate < 1%/Y at room temperature
- Storage life > 10 years
- Operating life² > 10 years

3.2 ASSEMBLIES

Type	Order No.	A (Max.)	B	C	D	E	F	G	H	I	K	L	M	Fig. No.	Tags
CR 1/2 AA S	6127 101 301	14.75	25.2	–	–	–	–	–	–	–	–	7.0	0.6	1	
CR 1/2 AA S PCBD	6127 201 301	14.75	25.2	10.0	1.0	1.0	–	25.4	–	3.0	5.0	–	–	2	
CR 1/2 AA S ST	6127 301 301	14.75	25.2	10.0	–	3.5	2.1	25.4	2.5	–	–	–	–	3	
CR 1/2 AA BE CD	6127 501 301	14.75	25.4	45.0	–	–	–	–	–	–	–	–	–	7	
CR 1/2 AA S CD	6127 601 301	14.75	25.4	–	7.5	–	–	33.5	–	–	–	–	–	6	(90°)
CR 1/2 AA S PCBS	6127 901 301	14.75	25.2	–	–	1.0	–	25.4	–	3.0	–	–	–	5	short pin
CR 1/2 AA S TP	6127 601 381	14.75	25.2	16.5	–	0.64	–	25.8	–	–	–	–	–	8	pin
CR 1/2 AA WC ¹⁾	6127 201 390	17.5	27.0	50.0	–	–	–	–	–	–	–	–	–	9	wire & connector
CR 2/3 AA S	6237 101 301	14.75	33.5	–	–	–	–	–	–	–	–	7.0	0.6	1	
CR 2/3 AA S PCBD	6237 201 301	14.75	33.5	10.0	1.0	1.0	–	33.7	–	3.0	5.0	–	–	2	
CR 2/3 AA S ST	6237 301 301	14.75	33.5	10.0	–	3.5	2.1	33.7	2.5	–	–	–	–	3	
CR 2/3 AA S CD	6237 501 301	14.75	33.5	45.0	–	–	–	–	–	–	–	–	–	7	
CR 2/3 AA S PCBS	6237 701 301	14.75	33.5	–	1.0	1.0	–	33.7	–	3.0	–	–	–	4	single pin
CR AA S	6117 101 301	14.75	50.0	–	–	–	–	–	–	–	–	7.0	0.6	1	
CR AA S PCBD	6117 201 301	14.75	50.0	10.0	1.0	1.0	–	50.2	–	3.0	5.0	–	–	2	
CR AA S ST	6117 301 301	14.75	50.0	10.0	–	3.5	2.1	50.2	2.5	–	–	–	–	3	
CR AA S CD	6117 501 301	14.75	50.2	45.0	–	3.5	–	–	–	–	–	–	–	7	
CR AA S PCBS	6117 701 301	14.75	50.0	–	1.0	1.0	–	50.2	–	3.0	–	–	–	4	single pin
CR AA S WC ¹⁾	6117 201 390	18	51.0	50.0	–	–	–	–	–	–	–	–	–	9	wire & connector

Material: nickel plated sheet-steel, tag thickness: 0.15 mm till 0.25 mm. SLF: tip tinned, all types in green shrink sleeve.

¹⁾ using connector: JST type: PHR2 (Other connector types available on request.)

Custom made assemblies are available on request for large volume.

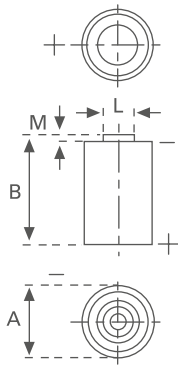

FIG. 1

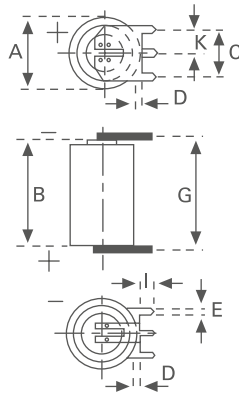

FIG. 2

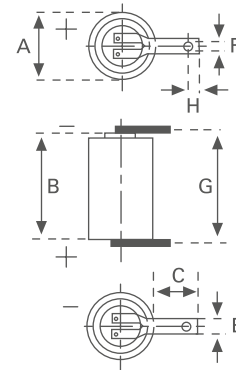

FIG. 3

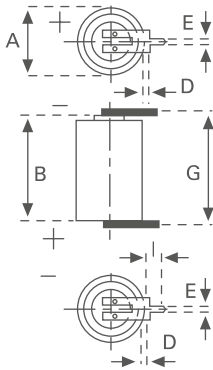

FIG. 4

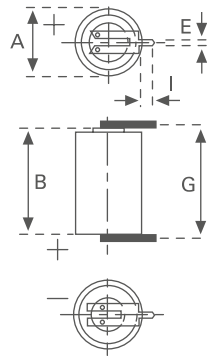
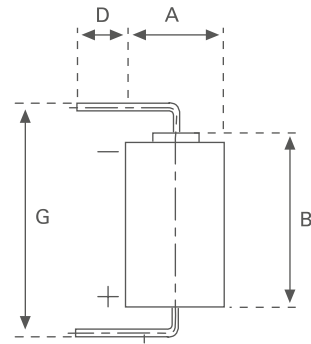

FIG. 5



Ni Ø 0,8 mm -
tinned

FIG. 6

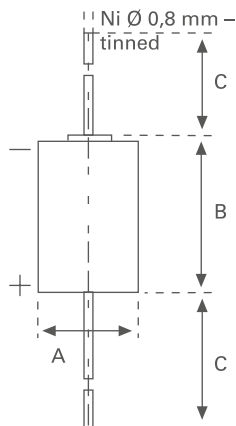

FIG. 7

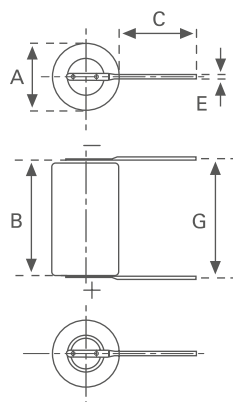

FIG. 8

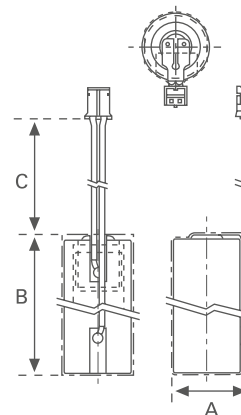
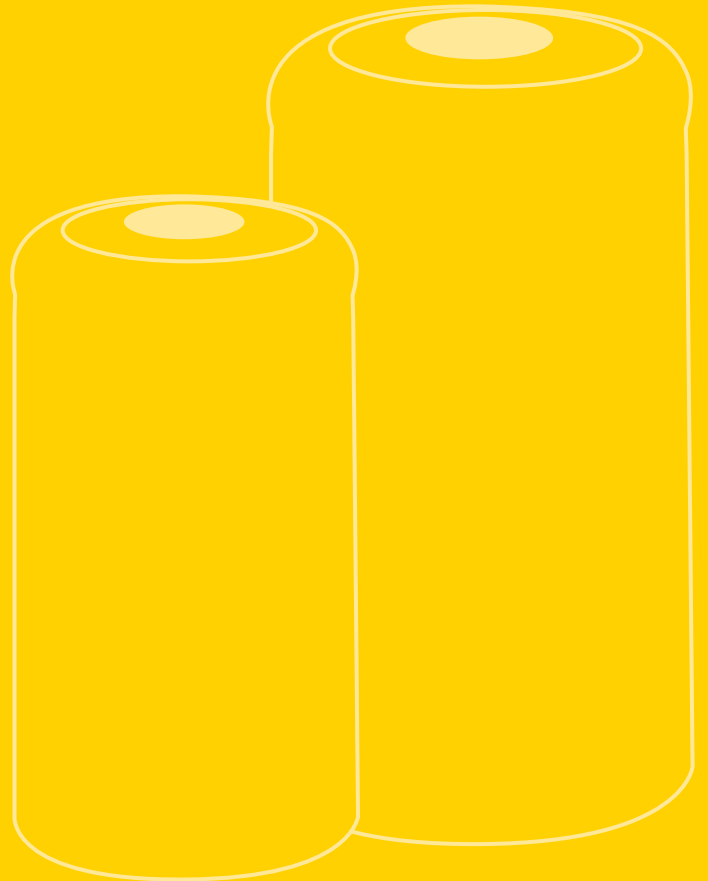

FIG. 9

4. CR HIGH POWER PRIMARY LITHIUM CYLINDRICAL CELLS



4.1	Types – Technical Data	35–41
4.2	Assemblies	42



4.1 TYPES – TECHNICAL DATA



CR 2



CR 123 A



CR 2/3 AH



CR 1/2 AAH-R



CR 2/3 AH-R



CR AH-R

Type	Order No.	Nominal voltage (V)	Nominal capacity at 20°C, load (mAh)	Max. continuous discharge current ¹⁾ (mA)	Weight (g)
CR 2	6206 210 501	3	850 mAh–200 Ω/2.0 V	885	11
CR 123 A	6205 210 501	3	1550 mAh–200 Ω/2.0 V	1400	17
CR 2/3 AH	6215 101 501	3	1500 mAh–200 Ω/2.0 V	1000	16
CR 1/2 AAH-R	6213 101 511	3	850 mAh–1mA/2.0 V	800	9
CR 2/3 AH-R	6214 101 511	3	1600 mAh–1mA/2.0 V	1500	17
CR AH-R	6217 101 511	3	2400 mAh–1mA/2.0 V	1500	23

Technical data, CR High Power Primary Lithium Cylindrical Cells

¹⁾ Current value for obtaining 50% capacity

CR 2

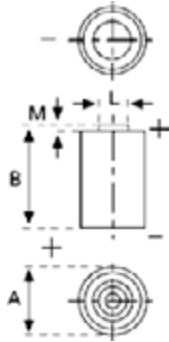

Type Number	6206
Designation IEC	CR 15H270
System	Li-Manganese dioxide/ Organic Electrolyte
UL Recognition	MH 13654 (N)
Nominal Voltage	3 V
Typical Capacity C	850 mAh (Load 200 kOhm, at 20°C down to 2 V)
Weight (approx.)	11 g
Volume	5,2 ccm
Coding	TBA

Temperature Ranges	min.	max.
Storage	-20°C	45°C
Discharge	-40°C	70°C ¹

Dimensions	min.	max.
Diameter (A)	15,10	15,60
Height (B)	26,30	27,00
Shoulder Diameter [L]	6,20	6,30
Shoulder Height [M]	0,70	1,30

Typical Capacities (at 20°C)

Discharge Type	Load	End Voltage: 2,0 V
Continuous 24 h/d, 7 d/w	200 Ω	Capacity: 850 mAh

Performance Data

Temperature Characteristics

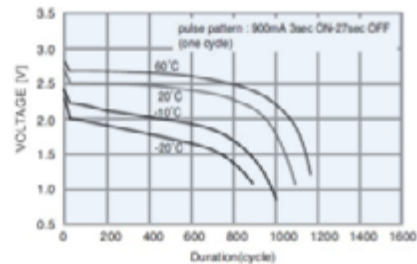

Pulse discharge characteristics*

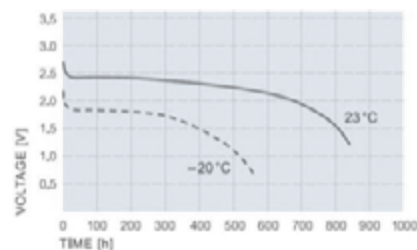

*1) Load: 0.9A. 3 sec on. 27 sec. off 2) after storage at 60°C/100 days

Discharge Characteristics*

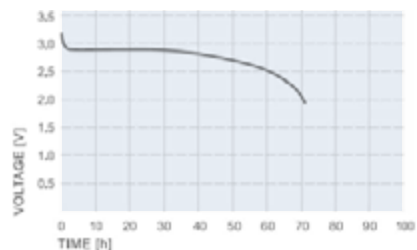

*at room temperature 21°C

¹ Contact VARTA if the application is intended to be outside the range of -40°C to +70°C.

² depending on environmental condition and energy consumption

- Self-discharge rate < 1%/Y at room temperature
- Storage life > 10 years
- Operating life² > 10 years

CR 123 A

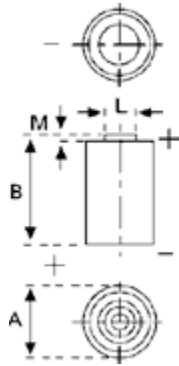

Type Number 6205
 Designation IEC CR 17345
 System Li-Manganese dioxide/
 Organic Electrolyte

UL Recognition MH 13654 (N)
 Nominal Voltage 3 V
 Typical Capacity C 1550 mAh (Load 100 kOhm,
 at 20°C down to 2 V)

Weight (approx.) 17 g
 Volume 7 ccm
 Coding Date of Manufacturing
 Month/Year

Temperature Ranges	min.	max.
Storage	-20°C	45°C
Discharge	-40°C	70°C ¹

Dimensions	min.	max.
Diameter (A)	16,40	17,00
Height (B)	34,30	34,50
Shoulder Diameter [L]	6,20	6,40
Shoulder Height [M]	1,18	1,23

Typical Capacities (at 20°C)

Discharge Type	Load	End Voltage: 2,0 V
Continuous 24 h/d, 7 d/w	100 Ω	Capacity: 1550 mAh

Performance Data

Temperature Characteristics*

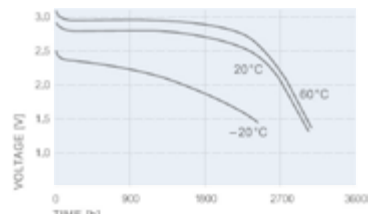

*Discharge Load 5,6 kΩ

Pulse discharge characteristics*

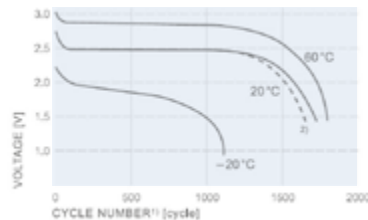

*1) Load: 0.9A. 3 sec on. 27 sec. off 2) after storage at 60°C/100 days

Typical discharge curve*

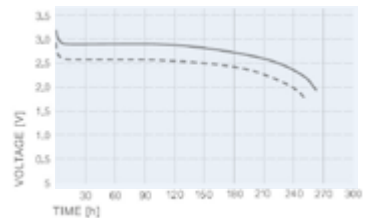

*Load: cont. 560 Ω, Pulse load: 2.sec/min 3Ω (parallel)

Discharge Characteristics*

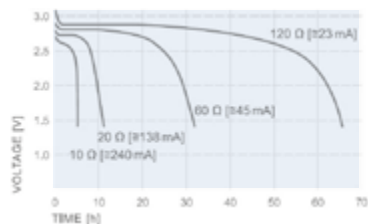

*at room temperature 21°C

¹ Contact VARTA if the application is intended to be outside the range of -40°C to +70°C.

² depending on environmental condition and energy consumption

- Self-discharge rate < 1%/Y at room temperature
- Storage life > 10 years
- Operating life² > 10 years

CR 2/3 AH

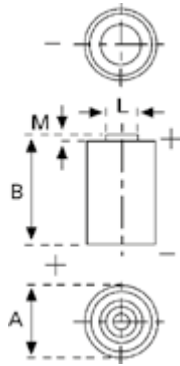

Type Number	6215
Designation IEC	CR 17345
System	Li-Manganese dioxide/ Organic Electrolyte
UL Recognition	MH 13654 (N)
Nominal Voltage	3 V
Typical Capacity C	1500 mAh (Load 200 kOhm, at 20°C down to 2 V)
Weight (approx.)	17 g
Volume	7 ccm
Coding	Date of Manufacturing Month/Year

Temperature Ranges	min.	max.
Storage	-20°C	45°C
Discharge	-40°C	70°C ¹

Dimensions	min.	max.
Diameter (A)	16,00	17,00
Height (B)	32,40	33,90
Shoulder Diameter [L]	6,10	
Shoulder Height [M]	1,00	

Typical Capacities (at 20°C)

Discharge Type	Load	End Voltage: 2,0 V
Continuous 24 h/d, 7 d/w	200 Ω	Time: 108 h Capacity: 1500 mAh Energy: 4190 mWh

Performance Data

Temperature Characteristics*

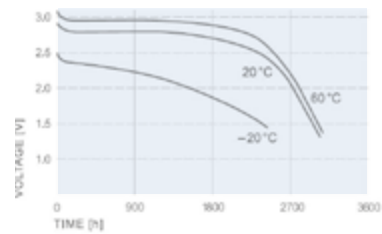

*Discharge Load 5,6 kΩ

Pulse discharge characteristics*

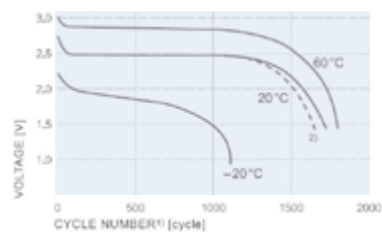

*1) Load: 0.9A, 3 sec on, 27 sec. off 2) after storage at 60°C/100 days

Typical discharge curve*

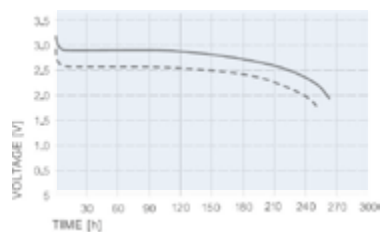

*Load: cont. 560 Ω, Pulse load: 2 sec/min 3Ω (parallel)

Discharge Characteristics*

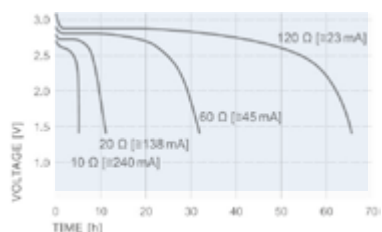

*at room temperature 21°C

¹ Contact VARTA if the application is intended to be outside the range of -40°C to +70°C.

² depending on environmental condition and energy consumption

- Self-discharge rate < 1%/Y at room temperature
- Storage life > 10 years
- Operating life² > 10 years

CR 1/2AAH-R

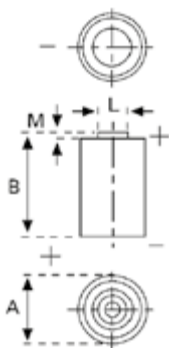

Type Number 6213
 Designation IEC CR 14250
 System Li-Manganese dioxide / Organic Electrolyte

UL Recognition # MH 13654
 Nominal Voltage 3 V
 Typical Capacity C 850 mAh (Current 1 mA, at 20°C down to 2 V)
 Maximum cont. Discharge 800 mA
 Maximum Pulse Discharge.... 1500 mA

Weight (approx.) 9 g
 Volume 5 ccm
 Coding Date of Manufacturing Quarter/Year

Temperature Ranges

	min.	max.
Storage	-20°C	45°C
Discharge	-40°C	70°C ¹

Dimensions

	min.	max.
Diameter (A)	13,82	14,22
Height (B)	24,65	24,95
Shoulder Diameter [L]	6,30	
Shoulder Height [M]	0,50	

Typical Capacities (at 20°C)

Discharge Type	Discharge	End Voltage: 2,0 V
Continuous 24h/7d/w	1 mA	Capacity[mAh]: 850

Performance Data

Temperature Characteristics

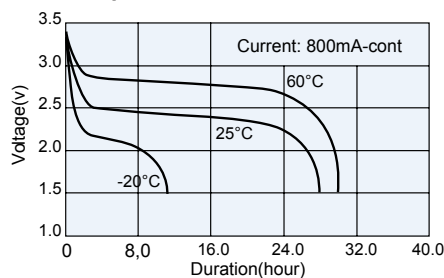

Pulse discharge characteristics

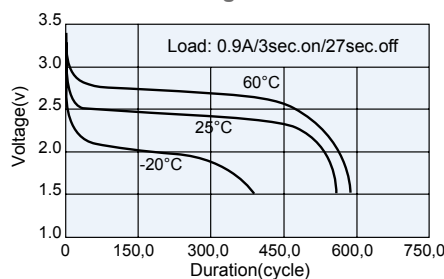

Discharge Characteristics

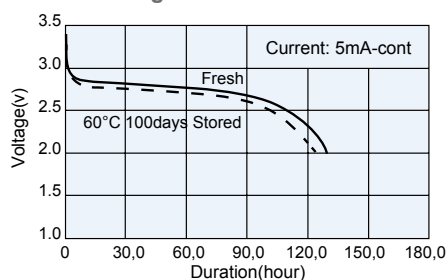

¹ Contact VARTA if the application is intended to be outside the range of -20°C to +60°C. / # pending

² depending on environmental condition and energy consumption

- Self-discharge rate < 1%/Y at room temperature
- Storage life > 10 years
- Operating life² > 10 years

CR 2/3AH-R

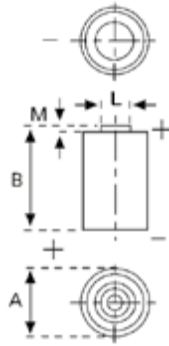

Type Number 6214
 Designation IEC CR 17335
 System Li-Manganese dioxide / Organic Electrolyte

UL Recognition # MH 13654
 Nominal Voltage 3 V
 Typical Capacity C 1600 mAh (Current 1 mA, at 20°C down to 2 V)
 Maximum cont. Discharge 1500 mA
 Maximum Pulse Discharge.... 3500 mA

Weight (approx.) 17 g
 Volume 7 ccm
 Coding Date of Manufacturing Quarter/Year

Temperature Ranges	min.	max.
Storage	-20°C	45°C
Discharge	-40°C	70°C ¹

Dimensions	min.	max.
Diameter (A)	16,20	16,80
Height (B)	32,50	33,50
Shoulder Diameter [L]	6,30	
Shoulder Height [M]	0,50	

Typical Capacities (at 20°C)

Discharge Type	Discharge	End Voltage: 2,0 V
Continuous 24h/7d/w	1 mA	Capacity[mAh]: 1600

Performance Data

Temperature Characteristics

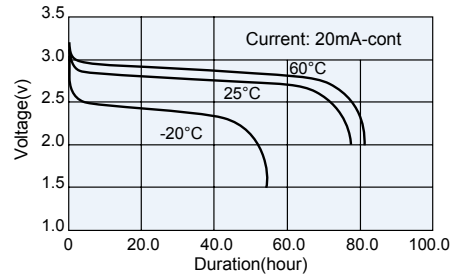

Pulse discharge characteristics

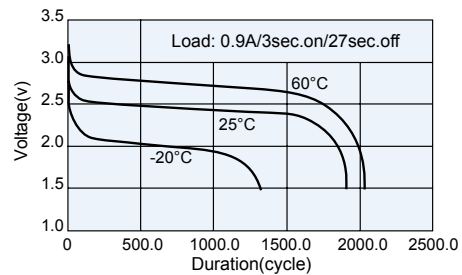

Discharge Characteristics

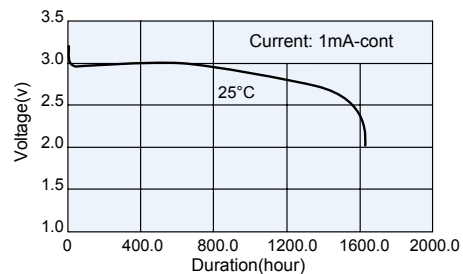

¹ Contact VARTA if the application is intended to be outside the range of -20°C to +60°C. / # pending

² depending on environmental condition and energy consumption

- Self-discharge rate < 1%/Y at room temperature
- Storage life > 10 years
- Operating life² > 10 years

CR AH-R

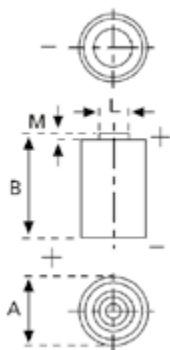

Type Number 6217
 Designation IEC CR 17450
 System Li-Manganese dioxide / Organic Electrolyte

UL Recognition MH 13654
 Nominal Voltage 3 V
 Typical Capacity C 2400 mAh (Current 1 mA, at 20°C down to 2 V)
 Maximum cont. Discharge 1500 mA
 Maximum Pulse Discharge.... 3500 mA

Weight (approx.) 23 g
 Volume 9,5 ccm
 Coding Date of Manufacturing Quarter/Year

Temperature Ranges	min.	max.
Storage	-20°C	45°C
Discharge	-40°C	70°C ¹

Dimensions	min.	max.
Diameter (A)	16,40	17,00
Height (B)	44,00	45,00
Shoulder Diameter [L]	6,30	
Shoulder Height [M]	1,45	

Typical Capacities (at 20°C)

Discharge Type	Discharge	End Voltage: 2,0 V
Continuous 24h/7d/w	1 mA	Capacity[mAh]: 2400

Performance Data

Temperature Characteristics

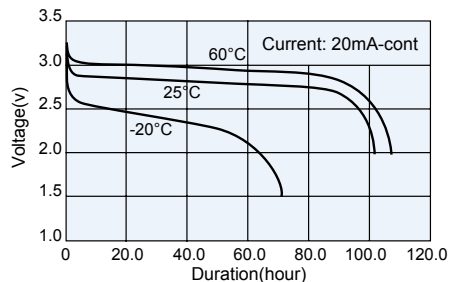

Pulse discharge characteristics

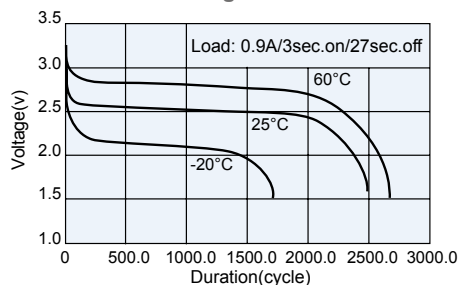

Discharge Characteristics

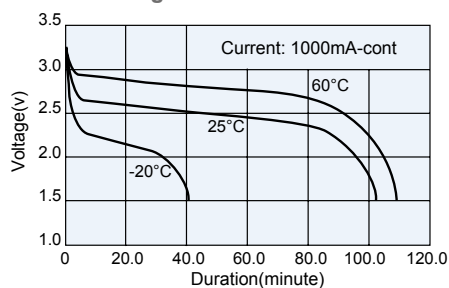

¹ Contact VARTA if the application is intended to be outside the range of -20°C to +60°C

² depending on environmental condition and energy consumption

- Self-discharge rate < 1%/Y at room temperature
- Storage life > 10 years
- Operating life² > 10 years

4.2 ASSEMBLIES

Type	Order No.	A	B	C	D	E	F	G	H	I	K	L	M	Fig. No.	Tags
CR 2/3 AH S	6215 101 501	17,0	33,9	-	-	-	-	-	-	-	-	6,3	1,0	1	-
CR 123A P1	6205 210 501	17,0	34,5	-	-	-	-	-	-	-	-	6,4	1,29	1	-
CR 2 P1	6206 210 501	15,6	27,0	-	-	-	-	-	-	-	-	6,5	0,7	7	-
CR 1/2 AAH-R	6213 101 511	14,0	24,8	-	-	-	-	-	-	-	-	6,3	0,5	1	-
CR 1/2 AAH-R PCBD	6213 201 098	14,5	24,8	10,0	-	1,00	-	25,5	-	4,5	5,0	-	-	2	-
CR 1/2 AAH-R S SLF	6213 201 097	14,5	24,8	-	-	0,75	-	25,5	-	4,5	-	-	-	3	single pin
CR 1/2 AAH-R TP	6213 201 096	14,5	24,8	23,0	-	0,64	-	25,7	-	-	-	-	-	4	terminal pin
CR 1/2 AAH-R WC	6213 201 099	16,5	27,0	30,0	-	-	-	-	-	-	-	-	-	5	wire & connector
CR 2/3 AH-R	6214 101 511	16,5	33,0	-	-	-	-	-	-	-	-	6,3	0,5	1	-
CR 2/3 AH-R PCBD	6214 201 097	17,0	33,0	-	-	1,00	-	33,5	-	4,5	5,0	-	-	2	-
CR 2/3 AH-R S SLF	6214 201 099	17,0	33,0	-	-	0,75	-	33,5	-	4,5	-	-	-	3	single pin
CR 2/3 AH-R TP	6214 201 096	17,0	33,0	22,0	-	0,64	-	33,5	-	-	-	-	-	4	terminal pin
CR 2/3 AH-R WC	6214 201 098	18,0	36,0	30,0	-	-	-	-	-	-	-	-	-	5	wire & connector
CR AH-R	6217 101 511	16,5	44,5	-	-	-	-	-	-	-	-	6,3	1,45	1	-
CR AH-R PCBD	6217 201 098	17,0	45,0	-	-	1,0	-	45,0	-	4,5	5,0	-	-	2	-
CR AH-R S SLF	6217 201 097	17,0	45,0	-	-	0,75	-	45,0	-	4,5	-	-	-	3	single pin
CR AH-R TP	6217 201 096	17,0	45,0	22,0	-	-	-	-	-	-	-	-	-	4	terminal pin
CR AH-R WC	6217 201 095	19,5	47,0	60,0	-	-	-	-	-	-	-	-	-	5	wire & connector
CR AH-R WC	6217 201 099	19,5	47,0	80,0	-	-	-	-	-	-	-	-	-	5	wire & connector

Material: nickel plated sheet-steel, tag thickness: 0.15 mm till 0.25 m. SLF: tip tinned.
Custom made assemblies are available on request for large volume.

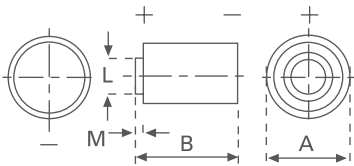

FIG. 1

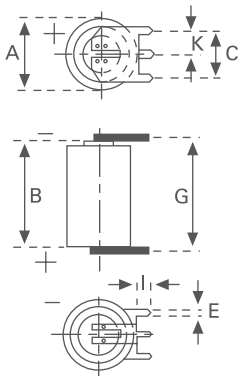

FIG. 2

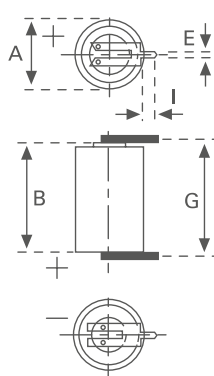

FIG. 3

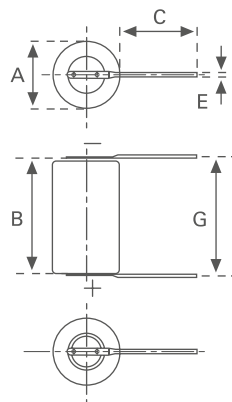

FIG. 4

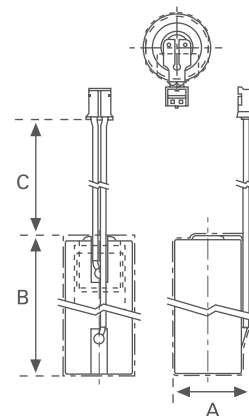

FIG. 5

5. GENERAL DESIGN CHARACTERISTICS

Basically, **VARTA** lithium batteries are safely designed to endure various environmental conditions. The design of the hermetically seal rim and the glass-to-metal welding can give the battery high endurance in various environmental conditions such as variant temperatures, humidity and vibration. Also, the position of lithium against the inner wall of the cell case makes heat dissipated to the outside easier when inside heat is generated. Therefore, there is no concern over safety when the suggested cautions are followed during usage, handling or storage.

However, there might be some possibilities of mishandling or misuse by the customer. Thus, following simulation tests have been performed. The test conditions are based on the procedures of the UL standard tests and Military Standards for environmental and safety testing. The abnormal test is only carried out to check the behavior of the batteries under misuse conditions and make certain the batteries react in a safe manor.

5.1	Safety Tests	46
5.2	Safety Guidelines	47
5.3	OEM – Application Check List.....	48–50

Battery Selection:

In order to ensure optimum battery performance for the primary CR Button, the cylindrical CR High Power and cylindrical High Capacity cells, we suggest consideration of the following design-in requirements. They are the nominal and operating voltage, load current and profile,

the duty cycle, temperature requirements and shelf life for the application. These characteristics for each battery type must be evaluated against the design requirements to select the most appropriate product that fulfills these requirements.

Design-in Considerations

VARTA Microbattery Primary Lithium Batteries offer light-weight packaged power for a variety of portable electric and electronic equipment. They are suitable as a main or standby power source for memory (RAM) and Real-Time clock (RTC) applications.

The Lithium Batteries are blocked from the power supply by means of a diode to prevent discharge of the battery into the DC supply during shut down.

The voltage drop across D1 should be taken into account as the minimum voltage of the load that has to be maintained under all circumstances.

Blocking diode D2 and D3 prevents the battery from being charged through the power supply. The amount of accumulated reverse current (IR) should be kept around 1% of the cell's typical capacity during its standby life time. The leakage current of the diodes has to be considered.

Example:

- CR 1/2 AA for 5 years life time
- 1% of 950 mAh = 9,5 mAh = 9500 μ Ah
- 5 years = 43800 h
- max. reserve current = 9500 μ Ah/ 43800 h = 0,217 μ A

However a maximum of 5 μ A continuously must not be exceeded. In the absence of a DC supply voltage, the lithium battery supplies the load with the necessary power.

As diodes fail at low current levels by an alloy-effect causing a severe reduction in impedance, an additional safety device must be incorporated.

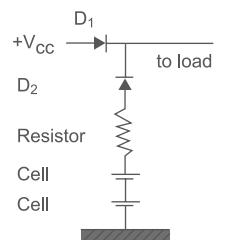
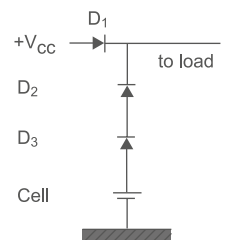
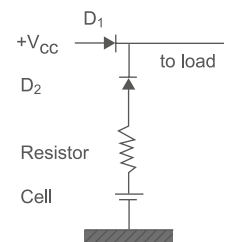

Using 2 cells when 6 V is used in series

Printed Circuit Board Mounting

Never solder on the body of the battery directly, use a battery equipped with PC-mount terminals. When using automatic soldering apply 250–270 °C within 5 seconds. Make sure that the battery is not suspended or dropped into the soldering bath.

Do not heat above 80 °C to avoid leakage caused by deterioration in the battery's performance.

UL-Recognition

All **VARTA** Microbattery Lithium Cells and Batteries are recognized by Underwriters Laboratories Inc. under UL-file number MH 13654 (N).

The cells are marked with the Recognized Component Mark.

Please also pay attention to the Safety Guidelines in Section 5.2.



®
Trademark of Underwriters
Laboratories

5.1 SAFETY TESTS

Example Short Circuit

In table 11 the temperature is listed at short circuit at an ambient temperature of 20°C, 40°C and 70°C.

Ambient temperature	CR 1/2 AA	CR 2/3 AA	CR AA
20°C	24°C	28°C	24°C
40°C	50°C	50°C	47°C
70°C	80°C	84°C	77°C

Vibration Test

Vibration test

Frequency range

5 Hz ► 55 Hz ► 500 Hz ► 55 Hz ► 5 Hz

Amplitude at frequency range:

5 to 55 Hz: ± 0.75 mm

Acceleration at frequency range:

55 Hz to 500 Hz: 100 m/s²

Cycle duration: 15 min

Oscillation time of each main axis: 3 h

Result

Without changing of the electrical values the following Li-cell can be exposed to this vibration test:

- CR 1/2 AA
- CR 2/3 AA
- CR AA

5.2 SAFETY GUIDELINES

For the current edition of the Material Safety Data Sheet (MSDS) please see:

https://www.varta-microbattery.com/fileadmin/varta_microbattery//mb_data/documents/material_safety_data_sheets/MSDS_08_Primary_Lithium_Cylindrical_Series_CR_en.pdf

https://www.varta-microbattery.com/fileadmin/varta_microbattery//mb_data/documents/material_safety_data_sheets/MSDS_07_Primary_Lithium_Cylindrical_Series_CR_Coiled_en.pdf

https://www.varta-microbattery.com/fileadmin/varta_microbattery//mb_data/documents/material_safety_data_sheets/MSDS_05_Primary_Lithium_Button_Series_CR_en.pdf

5.3 OEM – APPLICATION CHECK LIST

1. PROJECT INFORMATION

From (Writer)	Sales Agreement
Customer	Application
Name of the project	Country

2. MARKETING DATA

Yearly expectation of sales	Per batch of
Estimated selling price	Expected data of first order
Lifetime of the project	Start of volume production
Competitors Yes <input type="checkbox"/> No <input type="checkbox"/>	
Substitution of existing product	Which
Comments	

3. WHAT IS REQUIRED?

	Yes <input type="checkbox"/>	No <input type="checkbox"/>	Reply wishes for	Reply provided for
Feasibility study, preliminary proposal	<input type="checkbox"/>	<input type="checkbox"/>		
Technical proposal	<input type="checkbox"/>	<input type="checkbox"/>		
Preliminary drawing	<input type="checkbox"/>	<input type="checkbox"/>		
Samples to run electric tests	<input type="checkbox"/>	<input type="checkbox"/>		
Samples (with dummy cells)	<input type="checkbox"/>	<input type="checkbox"/>		
Prototypes (for qualification by the customer)	<input type="checkbox"/>	<input type="checkbox"/>		
Preliminary cost estimation (+/- 20%)	<input type="checkbox"/>	<input type="checkbox"/>		
Development and industrial cost estimation	<input type="checkbox"/>	<input type="checkbox"/>		
Product cost estimation (+/- 5%)	<input type="checkbox"/>	<input type="checkbox"/>		

4. TECHNICAL REQUIREMENTS

4.1. Storage before use

Duration	Temperature min.	Average	max.
Humidity			

4.2. Storage into the device before operating

Duration	Temperature min.	Average	max.
Humidity			

4.3. Specific tests prior incorporation

4.4. Electric data

Required minimum life time in use

Maximum voltage

Nominal capacity

Cut off voltage

Required minimum capacity

Current profile (average current, current pulse strength, pulse duration, pulse rate...)

Others

4.5. climatic data

Operating temperature min.	Average	max.
----------------------------	---------	------

Humidity

Others

4.6. Mechanical data (vibration, drop, bump, shock, ...)

Mention the applicable specification and enclose the document if necessary

4.7. Available dimensions: (weight, volume, if possible enclose the user drawing of the prospect)

4.8. Assembly (describe or enclose a drawing)

4.9. Applicable specifications / standards

UL BS UN IEC86-4 Other

— Reference and issue

4.10. Reliability level – Guarantees

4.11. Labeling and Packaging

VARTA standard labeling and packaging

Customised labeling (enclose the customer specification)

Customised packaging (enclose the customer specification)

4.12. Attached documents

Samples

Competitor samples

Drawing

Specification of the customer

Copy of specific standards

Samples of connector

Samples of specific components

Other

4.13. Additional information

Contact

Headquarters

VARTA Microbattery GmbH
VARTA-Platz 1,
73479 Ellwangen, Germany
Tel +49 7961 921-0
Fax +49 7961 921-553

France

VARTA Microbattery GmbH
12 - 14, Rue Raymond RIDEL
92250 La Garenne Colombes, France
Tel +33 1 47 84 84 54
Fax +33 1 47 84 28 32

Romania

VARTA Microbattery SRL
Str. Horia, Closca si Crisan, Nr. 61-63
075100 Otopeni, Jud. Ilfov, Romania
Factory:
VARTA Microbattery SRL
Boulevard Grivita 1
500177 Brasov, Romania
Tel +40 2 12 03 00 77

USA

VARTA Microbattery Inc.
555 Theodore Fremd Avenue,
Suite C 304 Rye, NY 10580, USA
Tel +1 914 592 25 00
Fax +1 914 345 04 88

Asia Pacific

VARTA Microbattery Pte. Ltd.
300 Tampines Avenue 5,
#05-01 Income
@ Tampines Junction,
529653 Singapore
Tel +65 6 260 58 01
Fax +65 6 260 59 60

Indonesia

PT VARTA Microbattery Indonesia
Jalan Gaharu Lot 23, Jalan
Angsana Lot 307-310
Batamindo Industrial Park,
Mukakuning,
Batam, KEPRI 29433, Indonesia
Tel +62 770 611 099
Fax +62 770 611 966

Hong Kong

VARTA Microbattery Pte. Ltd.
Room 1702-3, 17/F Fullerton Centre
19 Hung to Road, Kwun Tong
Kowloon, Hongkong
Tel +852 28 98 83 73
Fax +852 28 97 76 09

Taiwan

VARTA Microbattery Pte. Ltd.
3F No.85, Xinhu 1st Road,
Neihu District Taipei City 114,
Taiwan
Tel +886 2 27 90 29 92

Japan

VARTA Microbattery Japan K.K.
Kyobashi Y'SUS Bldg,
3F.1-6-12, Kyobashi, Chuo-Ku
Tokyo 104-0031, Japan
Tel +81 3 35 67 81 71
Fax +81 3 35 67 81 75

Representations and distributors in all major countries worldwide. Please see webpage.

VARTA Microbattery GmbH and **VARTA Storage GmbH** are companies of **VARTA AG**.



Visit us on our
youtube channel

<https://www.youtube.com/channel/UCR2dORIUzLktQ2MiZ3Fw2BA/videos>



www.linkedin.com/showcase/varta-microbatteries



<https://www.youtube.com/channel/UCR2dORIUzLktQ2MiZ3Fw2BA>



<https://de-de.facebook.com/varta.ag/>



<https://www.xing.com/companies/vartamicrobatterygmbh>

Our Brands:



