

Specifications

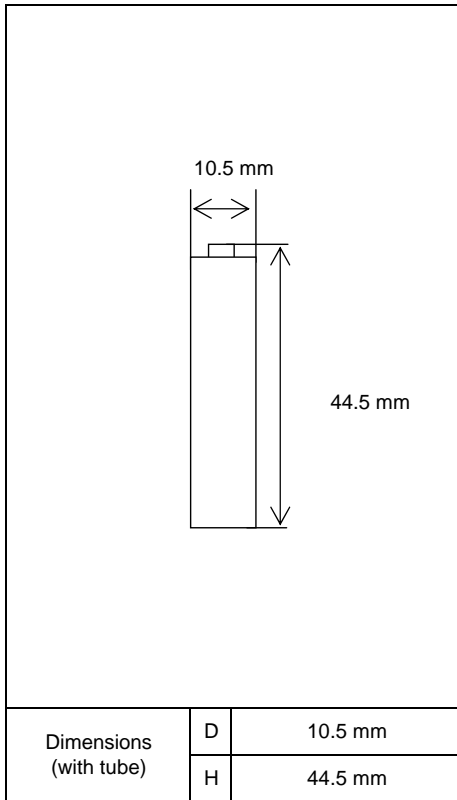

Type : Nickel-Metal Hydride Battery		Size : AAA Consumer Type	
Capacity ¹⁾	Typical	600mAh	
	Minimum	550mAh	
Nominal Voltage		1.2V	
Charging Current x Time	Fast Charge ²⁾	600mA × 1.1h	
Ambient Temp.	Charge Condition	Fast Charge ²⁾	
	Discharge Condition		
	Storage Condition	Less than 90days	0°C - 40°C
		Less than 1year	0°C - 50°C
Internal Impedance ³⁾ (after discharge to E.V.=1.0V)		Approx. 45mΩ(at 1000Hz)	
Weight ⁴⁾		Approx.11g	
Size ⁴⁾ : (Diameter) x (Height)		10.5(D) x 44.5(H) mm	

- 1)Single cell capacity under the following condition.
Charge : 60mA×16h, Discharge : 120mA(E.V.=1.0V) at 20°C
- 2)Use recommended charging system.
- 3)After a few charge and discharge cycles under the above 1) condition.
- 4)With tube.

Typical Characteristics

Charge

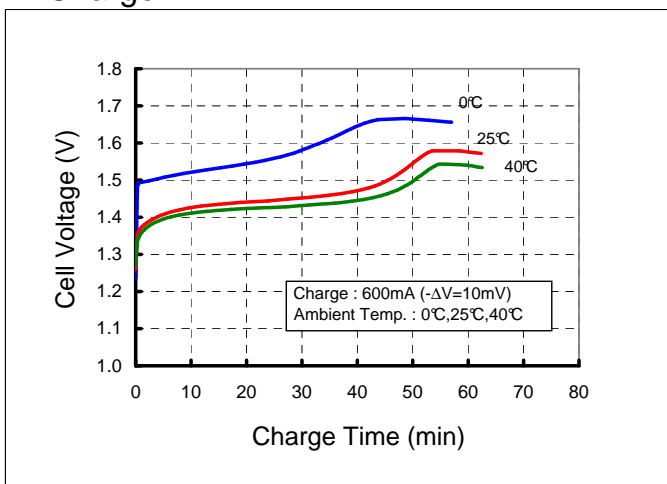

Discharge

