

Dimension (mm) *1

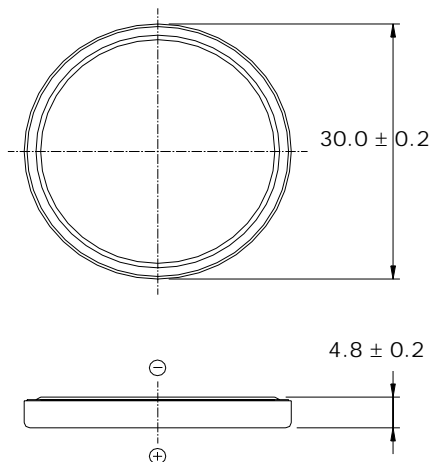

Discharge Characteristics I

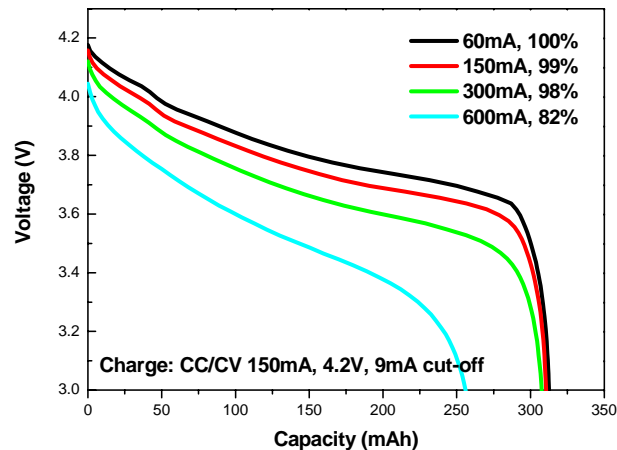

Discharge Characteristics II

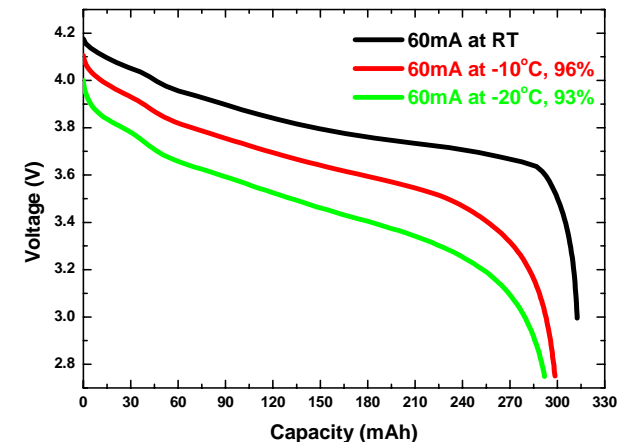

Specification

Nominal Voltage	3.7 V
Nominal Capacity *2	300 mAh
Dimension (mm)	4.8 x 30.0
Weight(Approx.)	9.3 g
Max. Discharge Current	2 CmA (600 mA)

*1 Dimensions of a fresh battery

*2 Discharged at 0.2CmA(60mA), 3V cut-off

Charge Characteristics

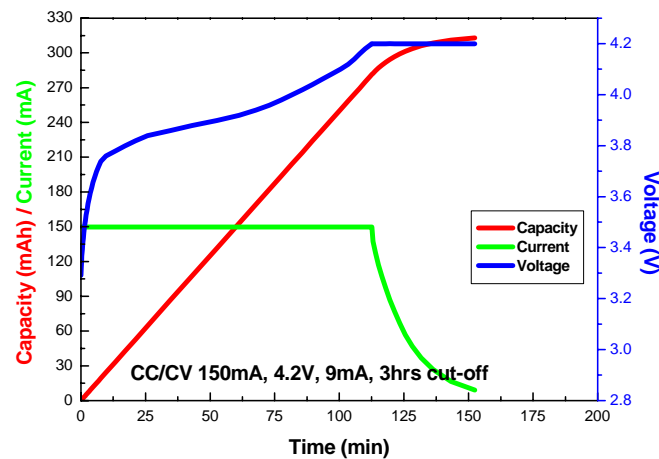

Cycle Life Characteristics

