



10.8V

13.8Ah

Lilon

149Wh

Waterproof Energy Storage System Self Contained Lithium Ion Battery

FEATURES

The LIBM-OAR10814 is a self-contained 10.8V Lithium Ion battery pack which provides a reliable and consistent power output of up to 13.8Ah (149Wh).

Designed within a high-quality waterproof, dustproof and shockproof IP67 case, the LIBM-OAR battery is suitable for all type of outdoor applications.

It is equipped with an IP67 DC connector, capable of supplying current up to 5A to the load; and a protection circuit module for over-charge, under-discharge, over-current and short-circuit scenarios.

The unit includes a IP67 DC Female pigtail to be installed in any device.



SPECIFICATIONS

Model Number	LIBM-OAR10814	
Battery Type	Chemistry	Lithium Ion (Lilon)
	Pack Configuration	3S4P
	Battery cell	INR18650-35E SAMSUNG 3.6V 3.5Ah
	Capacity [Ah]	13.8Ah
	Power [Wh]	149.04Wh
Voltage	Nominal Voltage	10.8 VDC
	Voltage Range	9 ~ 12.6 VDC
Current	Nominal Current	5A (continuous discharging)
	Maximum Current	7A (maximum peak)
Protections	Over-charging	YES
	Under-discharging	YES
	Over-current	YES
	Short-circuit	YES
Connector	IP67 DC 5.5mm x 2.1mm - male	
Charger*	CC/CV 12.6VDC	
	3A recommended (5A max)	
Dimensions	80mm (W) x 70mm (H) x 110mm (L)	
Weight	810g	
Temperature	Charging	0°C to +45°C
	Discharging	-20°C to +60°C
	Storage	-20°C to +60°C
Ingress Protection Rating	IP67 - Waterproof, dustproof and shockproof	

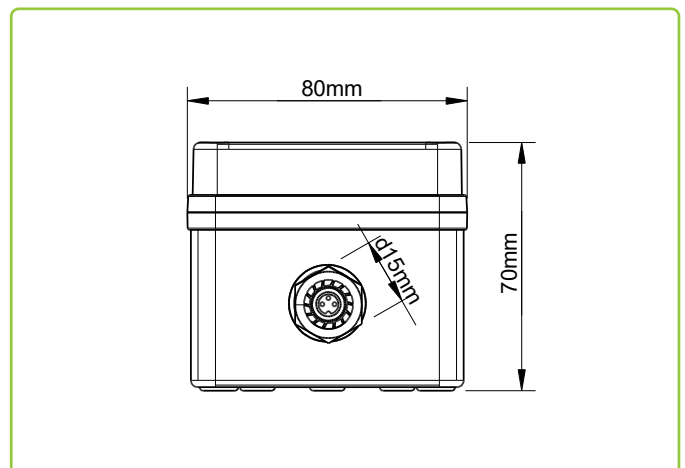
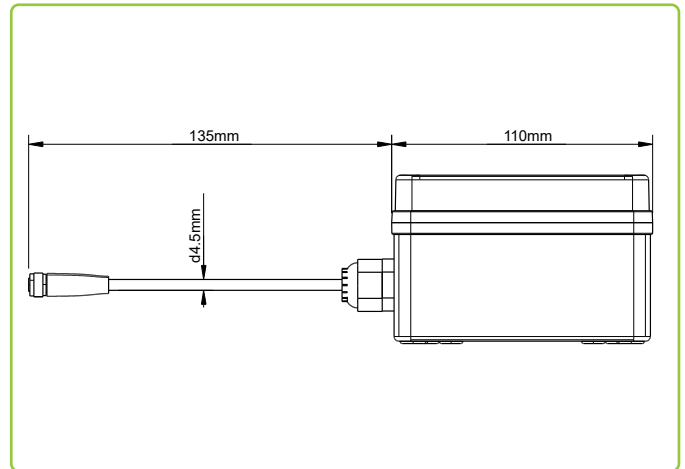

*FY1263000 charger recommended. Not included.

All specifications are correct at time of creation. All specifications and operation conditions contained in this datasheet are subject to change or improvement without prior notice to the user. This data is for evaluation purposes only. No guarantee is intended or implied by this data. For clarification and updated information, please contact us.