



Pylon Technologies Co., Ltd.

No. 73, Lane 887, Zu Chongzhi Road, Zhangjiang Hi-Tech Park Pudong,
Shanghai 201203, China

Lithium-Ion Phosphate Battery

PowerCube-X1 Product Manual

Information Version: 3.0

Pylon Technologies Co., Ltd.

No. 73, Lane 887, ZuChongzhi Road, Zhangjiang Hi-Tech Park
Pudong, Shanghai 201203, China Zip Code: 201203

Tel: 021-51317697

Fax: 021-51317698

Email: service@pylontech.com.cn

Website: <http://www.pylontech.com.cn>



This manual introduces PowerCube-X1 from Pylontech. PowerCube-X1 is a high voltage Lithium-Ion Phosphate Battery storage system. Please read this manual before you install the battery and follow the instruction carefully during the installation process. Any confusion, please contact Pylontech immediately for advice and clarification.

Contents

1. SAFE HANDLING OF LITHIUM BATTERIES GUIDE	3
Before Connecting	3
In Using	3
2. INTRODUCTION	5
2.1 features.....	5
2.2 Specifications	6
2.2.1 Battery System.....	6
2.2.2 Battery Module.....	8
Battery Module Front Interface	9
2.2.3 Control Module (internal power supply).....	10
Definition of RJ45 Port Pin	11
LED Indicators Instructions	11
2.2.4 3 rd Level Control Module (MBMS).....	13
Definition of RJ45 Port Pin	14
LED Indicators Instructions	14
3. INSTALLATION	16
3.1 Tools.....	16
3.2 Safety Gear.....	16
3.3 Package Items	16
Accessories	16
Unpacking and check the Packing List:	16
3.4 Installation Location	18
Installation	19
5. TROUBLE SHOOTING STEPS	21
6. EMERGENCY SITUATIONS	22

1. Safe handling of lithium batteries Guide



Warning: This product is a high voltage DC system, operated by authorized person only.



Warning

Before Connecting

- 1) After unpacking, please check product and packing list first, if product is damaged or lack of parts, please contact with the local retailer;
- 2) Before installation, be sure to cut off the grid power and make sure the battery is in the turned-off mode;
- 3) Wiring must be correct, do not mistake the positive and negative cables, and ensure no short circuit with the external device;
- 4) It is prohibited to connect the battery and AC power directly;
- 5) Battery system must be well grounded and the resistance must be less than 1Ω ;
- 6) Please ensured the electrical parameters of battery system are compatible to related equipment;
- 7) Keep the battery away from water and fire.

In Using

- 1) If the battery system needs to be moved or repaired, the power must be cut off and the battery is completely shutdown;
- 2) It is prohibited to connect the battery with different type of battery.
- 3) It is prohibited to put the batteries working with faulty or incompatible inverter;
- 4) It is prohibited to disassemble the battery (QC tab removed or damaged);
- 5) In case of fire, only dry powder fire extinguisher can be used, liquid fire extinguishers are prohibited;
- 6) Please do not open, repair or disassemble the battery except staffs from Pylontech or authorized by Pylontech. We do not undertake any consequences or related responsibility which because of violation of safety operation or violating of design, production and equipment safety standards.



Reminded

- 1) Please read the user manual carefully (in the accessories);
- 2) If the battery is stored for long time , it is required to charge them every six months, and the SOC should be no less than 80%;
- 3) Battery needs to be recharged within 12 hours, after fully discharged;
- 4) Do not expose cable outside;
- 5) All the battery terminals must be disconnected for maintenance;
- 6) Please contact the supplier within 24 hours if there is something abnormal.
- 7) The warranty claims are excluded for direct or indirect damage due to items above.

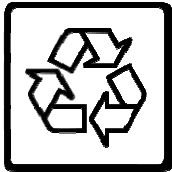

Li-ion



2. Introduction

PowerCube-X1 is a high voltage battery storage system based on lithium iron phosphate battery, is one of new energy storage products developed and produced by Pylontech, it can be used to support reliable power for various types of equipments and systems. PowerCube-X1 is especially suitable for application scene of high power, limited installation space, restricted load-bearing and long cycle life.

PowerCube-X1 has 2 levels BMS (battery management system), which can manage and monitor cells information including voltage, current and temperature. What's more, BMS can balance cells charging and discharging to extend cycle life. Multiple batteries can connected in parallel to expand capacity and power in parallel for larger capacity and longer power supporting duration requirements.

2.1 features

- The whole module is non-toxic, non-polluting and environmentally friendly;
- Cathode material is made from LiFePO₄ with safety performance and long cycle life;
- Battery management system (BMS) has protection functions including over-discharge, over-charge, over-current and high/low temperature;
- The system can automatically manage charge and discharge state and balance current and voltage of each cell;
- Flexible configuration, multiple battery modules can be in serial for expanding voltage and capacity.
- Adopted self-cooling mode rapidly reduced system entire noise;
The module has less self-discharged, up to 6 months without charging ion shelf; no memory effect, excellent performance of shallow charge and discharge;
- Working temperature range is from 0°C to 50°C, with excellent discharge performance and cycle life;
- Small size and light weight, standard of 19-inch embedded designed module is comfortable for installation and maintenance;

Caution: PowerCube-X1 without soft-start circuit. So must choose the Inverter, which has soft-start function, otherwise has the risk of equipment breakdown.

2.2 Specifications

2.2.1 Battery System

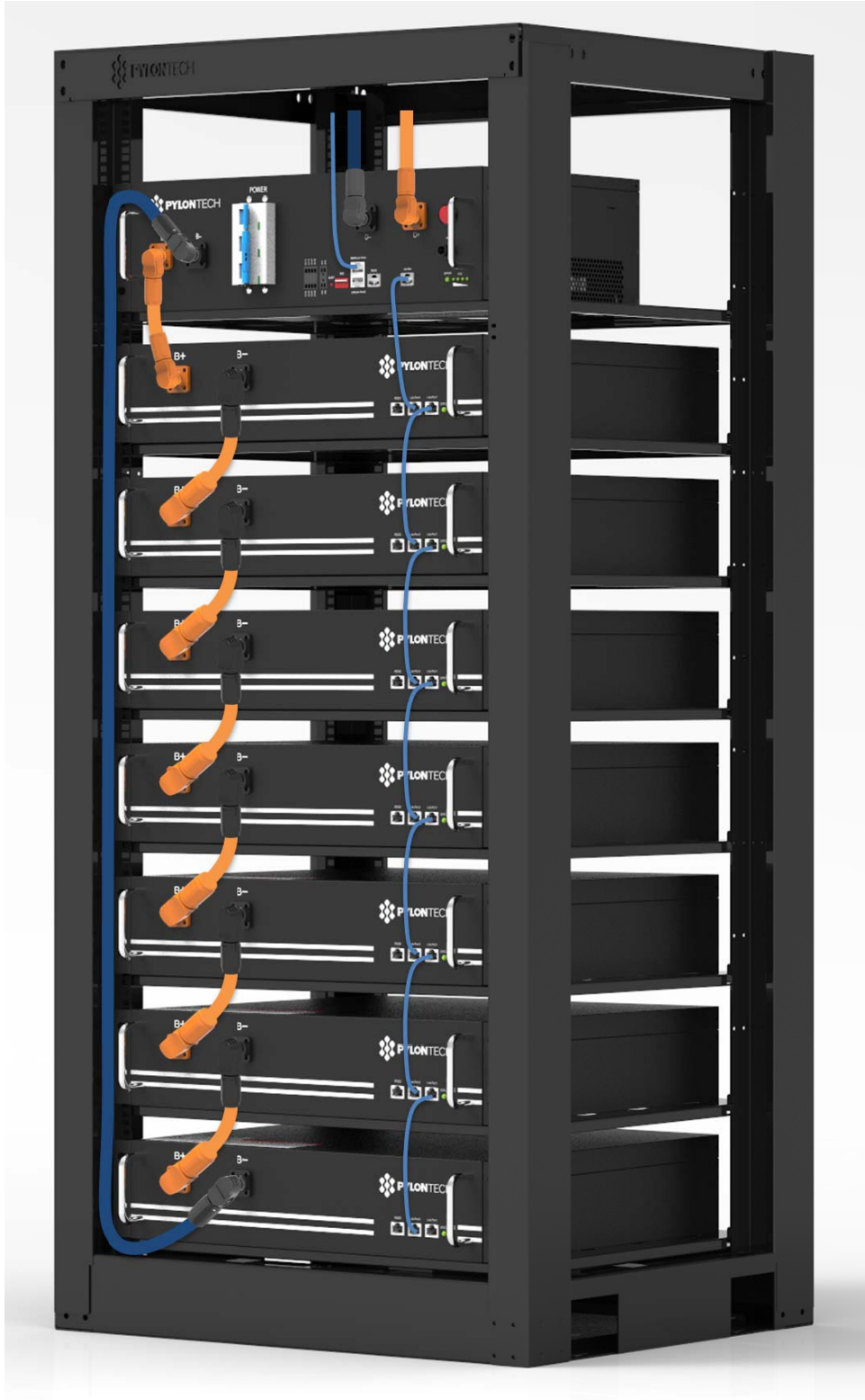

No.	Item	PowerCube-X1 (336V50AH)
1	Cell Technology	Li-ion (LFP)
2	Battery System Capacity (kWh)	16.8
3	Battery System Voltage (V _{dc})	336
4	Battery System Capacity (Ah)	50
5	Battery Controller Name	SC0500-100
6	Battery Module Name	H48050
7	Battery Module Quantity (pcs)	7
8	Battery Module Capacity (kWh)	2.40
9	Battery Module Voltage (V _{dc})	48
10	Battery Module Capacity (Ah)	50
11	Battery Module Cell Quantity (pcs)	15
12	Battery System Charge Voltage (V _{dc})	378
13	Battery System Charge Current (Standard)	10
14	Battery System Charge Current (Normal)	25
15	Battery System Charge Current (Max.)	50
16	Battery System Discharge lower-Voltage (V _{dc})	315
17	Battery System Discharge Current (Standard)	10
18	Battery System Discharge Current (Normal)	25
19	Battery System Discharge Current (Max.)	50
20	Efficiency	96%
21	Depth of Discharge	80% (10~90%)
22	Dimension (W*D*H, mm)	600*505*1300
23	Communication	RS485 / CAN
24	Protection Class	IP20
25	Weight (kg)	250
26	Operation Life (Years)	10
27	Operation Cycle Life	3500
28	Operation Temperature (°C)	0~50
29	Storage Temperature (°C)	-20~60
30	Product Certificate	TÜV, CE
31	Transfer Certificate	UN38.3
32	Other: 1) Battery Controller Dimensions (W*D*H) 2) Battery Module Dimensions (W*D*H)	442*390*132 442*390*100

Remark: The parameter will be changed when the battery modules in different series (3~7 pcs battery modules).

2.2.2 Battery Module



No.	Product Type	H48050A-15S
1	Cell Technology	Li-ion (LFP)
2	Battery Module Capacity (kWh)	2.4
3	Battery Module Voltage (Vdc)	48
4	Battery Module Capacity (AH)	50
5	Battery Module Quantity (pcs)	30
6	Battery Cell Capacity (Wh)	80
7	Battery Cell Voltage (Vdc)	3.2
8	Battery Cell Capacity (AH)	25
9	Battery Module Cell Quantity in Series (pcs)	15
10	Battery Module Charge Voltage (Vdc)	54
12	Battery System Charge Current (Standard)	10
13	Battery Module Charge Current (Normal)	25
14	Battery Module Charge Current (Max.)	50
15	Battery Module Discharge lower-Voltage (Vdc)	45
16	Battery System Discharge Current (Standard)	10
17	Battery Module Charge Current (Normal)	25
18	Battery Module Charge Current (Max.)	50
19	Efficiency	96%
20	Depth of Discharge	80% (10~90%)
21	Dimension (W*D*H, mm)	442*390*100
22	Communication	RS485 / CAN
23	Protection Class	IP20
24	Weight	24
25	Operation Life	10+Years
26	Operation Cycle Life	4000
27	Operation Temperature	0~50°C
28	Storage Temperature	-20~60°C
29	Product Certificate	TÜV (IEC62619)
30	Transfer Certificate	UN38.3

Battery Module Front Interface



Power Terminal +/-

To connect battery series power cables.

Status

Status light: to show the battery module's status (RUN ●, Alarm ● and Protection ●).

RS232 Terminal

Console Communication Terminal: (RJ45 port) follow RS232 protocol, for manufacturer or professional engineer to debug or service.

Link Port 0, 1

Link Port 0, 1 Communication Terminal: (RJ45 port) follow RS485 protocol, for communication between multiple serial battery modules and control module.

Power Terminals

Power cable terminals: there are two pair of terminals with same function, one connect to equipment, the other one paralleling to other battery module for capacity expanding. For each single module, each terminal can achieve charging and discharging function.

For power cables uses water-proofed AMPHENOL connectors. It must keep pressing this Lock Button during pulling out the power plug.

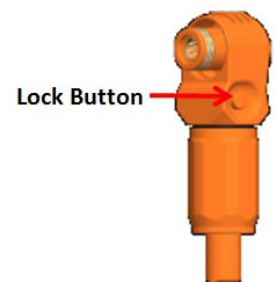

2.2.3 Control Module (internal power supply)

Control Module has two types: **internal** and **external** power supply.

Control Module (SC0500A-100S) Front Interface

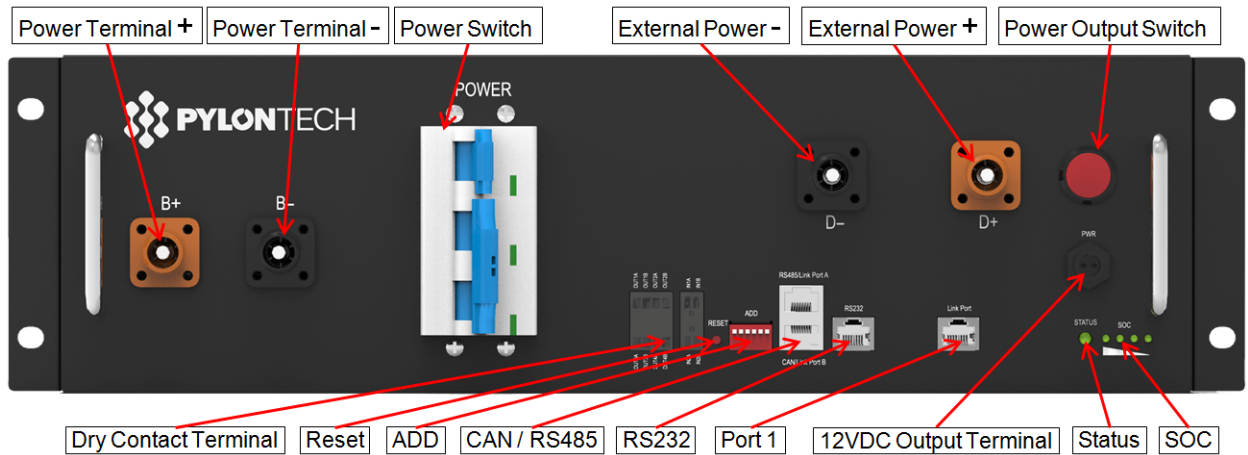

Power Terminal +/-

To connect battery power cables in series.

Power Switch

Switch the battery system's (control module and high voltage DC power) ON/OFF.

External Power Terminal +/-

Connect battery system with Inverter.

Dry Contact Terminal

Dry Contact Terminal: provided 2 input and 4 output dry contact signal.

Reset

Reset Button: Long press this button to restart the battery system.

ADD

ADD: 6 bit dial switches to manually distribute the communication address of the battery system. Nether position is OFF, means "0". Upper position is ON, means "1". 1st bit to 5th bit is for address, and the 6th bit dial switch support a 120 Ω resistance.

Power Output Switch

To control the high voltage DC power ON/OFF during the System Switch ON. Normally it turns in ON position, needn't turn it OFF.

CAN / RS485

CAN Communication Terminal: (RJ45 port) follow CAN protocol, for communication between battery system and Inverter.

RS485 Communication Terminal: (RJ45 port) follow RS485 protocol, for communication between battery system and Inverter.

RS232 Terminal

Console Communication Terminal: (RJ45 port) follow RS232 protocol, for manufacturer or professional engineer to debug or service.

Link Port 1

Link Port 1 Communication Terminal: (RJ45 port) follow CAN protocol, for communication between multiple serial battery modules and control module.

Definition of RJ45 Port Pin

No.	CAN	RS485	RS232 Pin
1	---	---	---
2	GND	---	---
3	---	---	TX
4	CANH	---	---
5	CANL	---	---
6	---	GND	RX
7	---	RS485A	---
8	---	RS485B	GND

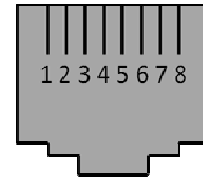

12VDC Output Terminal

Power supply for 3rd level control module, with 12VDC cable:

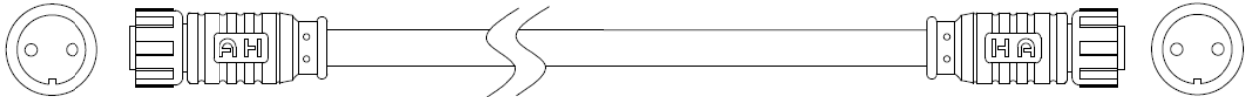

Status

Status light: to show the battery module's status (RUN●, Alarm● and Protection●).

LED Status Indicators

✧ Battery capacity indicator (No.8 Figure 2-1): 4 green lamps, each light represent 25% capacity.

LED Indicators Instructions

Battery Statuses	Protection / Alarm / Normal	RUN	ALM	PRC	Capacity SOC				Descriptions
		●	●	●	●	●	●	●	
Shut Down		Off	Off	Off	Off	Off	Off	Off	All off
Sleep	Normal	Flash 1	Off	Off	Off	Off	Off	Off	Indicates Sleep Mode, to save the power.

Standby	Normal	Flash 1	Off	Off	Off	Off	Off	Off	Indicates save power mode.
	Alarm	Off	Light	Off	Off	Off	Off	Off	Indicates the battery is low.
Standby	Normal	Flash 1	Off	Off	Off	Off	Off	Off	Indicates Standby
Charge	Normal	Light	Off	Off	The highest capacity indicator LED flashes (flash 2), others lighting				The highest capacity indicator LED flashes (flash 2), others lighting
	Alarm	Off	Light	Off					
	Protection	Off	Off	Light	Off	Off	Off	Off	Stop charging, PRC lighting
Discharge	Normal	Flash 3	Off	Off	Indicate based on capacity				Indicate based on capacity
	Alarm	Off	Light	Off					Stop discharging, PRC lighting
	Protection	Off	Off	Light					
Abnormal	Protection	Off	Off	Light	Off	Off	Off	Off	Stop charging/discharging, PRC lighting

Note: The flashing instructions, flash 1 –0.25s light / off 3.75 seconds; flash 2 - 0.5s light / 0.5s off; flash 3 - 0.5s light / 1.5s off.



External power supply Control Module

External power supply Control Module has an Australia standard AC Power input socket and power switch. It is applied with UPS system.

For external power supply control module there is additional AC power cable:

Australia Standard



Or

Europe Standard



2.2.4 3rd Level Control Module (MBMS)

MBMS is the controller for multiple battery piles in parallel connection.



If the power supply is 220Vac, an adaptor (220Vac to 12Vdc) will be provided.

Serial Number	Product Model	MBMS1000
1	Operating voltage range	12 Vdc
2	Communication interface	CAN/RS485
3	Output dry contact interface	4 groups
4	Input dry contact interface	2 groups
5	System Consumption	2W
6	Size	442*190*44mm
7	Protection degree	IP20
8	Weight (kg)	5
9	Working temperature	-20~60°C
10	Storage temperature	-40~80°C

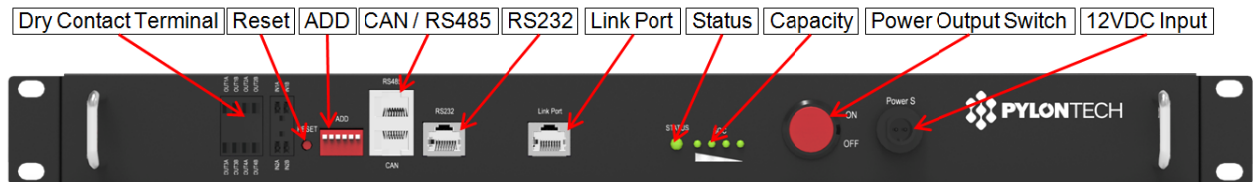

Dry Contact Terminal OUT1A/OUT1B...OUT4A/OUT4B, IN1A/IN1B/IN2A/IN2B

Dry Contact Terminal: provided 2 way input and 4 ways output dry contact signal.

Reset Reset

Reset Button: Long press this button to restart the battery system.

ADD ADD

ADD: 6 bit dial switches to manually distribute the communication address of the battery systems. Nether position is OFF, means "0". Upper position is ON, means "1". The MBMS's ADD Switch can be set up with "100001".

Code Bits					
1	2	3	4	5	6
ON	OFF	OFF	OFF	OFF	ON

CAN / RS485

RS485; CAN

CAN Communication Terminal: (RJ45 port) follow CAN protocol, for communication between battery system and PCS.

RS485 Communication Terminal: (RJ45 port) follow RS485 protocol, for communication between battery system and PCS.

RS232 Terminal

RS232

Console Communication Terminal: (RJ45 port) follow RS232 protocol, for manufacturer or professional engineer to debug or service.

Link Port

Link Port

Link Port Communication Terminal: (RJ45 port) follow RS485 protocol, for communication between multiple serial battery modules and control module.

Definition of RJ45 Port Pin

No.	CAN	RS485	RS232 Pin	Link Port Pin
1	---	---	---	---
2	GND	---	---	GND
3	---	---	TX	---
4	CANH	---	---	CANH
5	CANL	---	---	CANL
6	---	GND	RX	---
7	---	RS485A	---	---
8	---	RS485B	GND	---

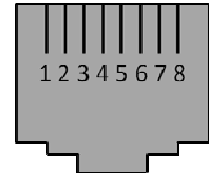

Status

Status light: to show the battery module's status (RUN●, Alarm● and Protection●).

LED Status Indicators

✧ Battery capacity indicator (No.8 Figure 2-1): 4 green lamps, each light represent 25% capacity.

LED Indicators Instructions

Battery Statuses	Protection / Alarm / Normal	RUN	ALM	PRC	Capacity SOC				Descriptions
		●	●	●	●	●	●	●	
Shut Down		Off	Off	Off	Off	Off	Off	Off	All off
Sleep	Normal	Flash 1			Off	Off	Off	Off	
	Alarm		Light		Off	Off	Off	Off	

Standby	Normal	Flash 1	Off	Off	Off	Off	Off	Off	Indicates Standby
Charge	Normal	Light	Off	Off	The highest capacity indicator LED flashes (flash 2), others lighting				
	Alarm	Off	Light	Off					
	Protection	Off	Off	Light	Off	Off	Off	Off	Stop charging, ALM lighting
Discharge	Normal	Flash 3	Off	Off	Indicate based on capacity				
	Protection	Off	Light	Light	Off	Off	Off	Off	Stop discharging, ALM lighting

Note: The flashing instructions, flash 1 - light 0.25s / off 3.75 seconds; flash 2 - 0.5s light / 0.5s off; flash 3 - 0.5s light / 1.5s off.

Power Output Switch

Turn ON/OFF the MBMS power, and ON/OFF the power output of external power of control modules.

12VDC Input

Take 12VDC power from outside (from control module or AC/DC adaptor).

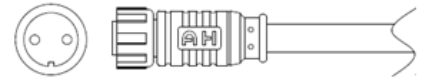

3. Installation

3.1 Tools

The following tools are required to install the battery pack



Wire Cutter



Crimping Modular Plier



Screw Driver Set

NOTE

Use properly insulated tools to prevent accidental electric shock or short circuits.

If insulated tools are not available, cover the entire exposed metal surfaces of the available tools, except their tips, with electrical tape.

3.2 Safety Gear

It is recommended to wear the following safety gear when dealing with the battery pack



Insulated gloves



Safety goggles



Safety shoes

3.3 Package Items

Accessories

The type and quantity of the accessories are subject to the battery packing list.

Unpacking and check the Packing List:

Power Cable + (Connection for Battery Series + to Control Module +)	Orange/0.16m/4AWG/2 Orange Surlok Terminal	pcs	1
---	--	-----	---

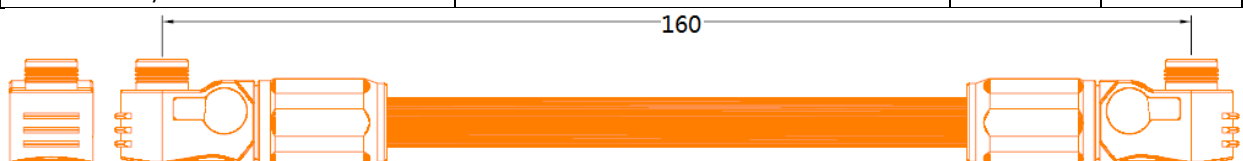

Power Cable - (Connection for Battery Series - to Control Module -)	Black/1.5m/4AWG/2 Black Surlok Terminal	pcs	1
---	---	-----	---

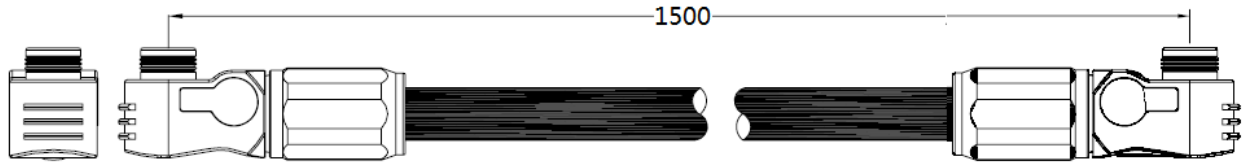

Power Cable (Battery Module Serial Connection)	Orange/0.18m/4AWG/1 Orange & 1 Black Surlok Terminal	pcs	7
--	--	-----	---

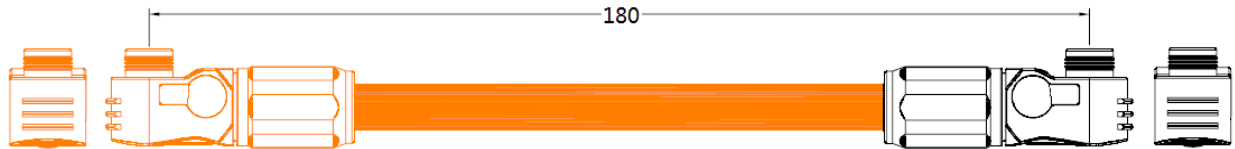

Battery Cascade Communication Cable (0.18m)	Black/0.18m/8 Core Super 5th Class Twisted-pair Wire/RJ45	pcs	8
---	---	-----	---

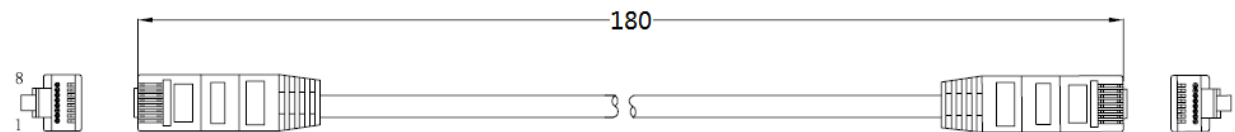

External Battery CAN Communication Cable (direct)	Black/3.5m/Super 5th Class Twisted-pair Wire/2 RJ45 terminal	pcs	1
---	--	-----	---

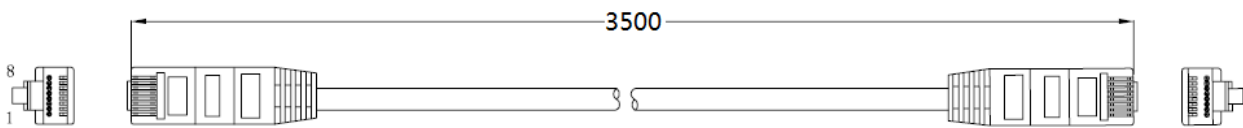

External Power Cable +	Orange/2m/4AWG/SURLOK Terminal/25-8 Terminal	pcs	1
------------------------	--	-----	---

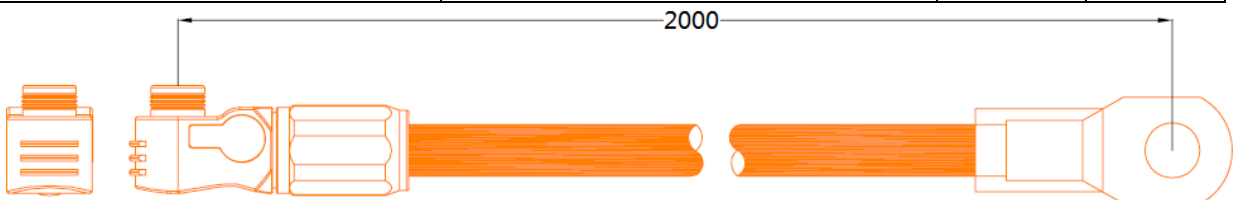

External Power Cable -	Black/2m/4AWG/SURLOK Terminal/25-8 Terminal	pcs	1
------------------------	---	-----	---

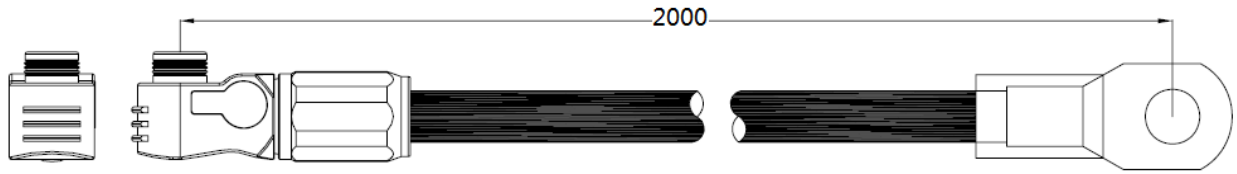

For external power supply control module there is additional AC power cable:

AC Power Cable (Australia Standard)	Black/2.5m/3*0.75mm ² /Australia Standard	pcs	1
-------------------------------------	--	-----	---

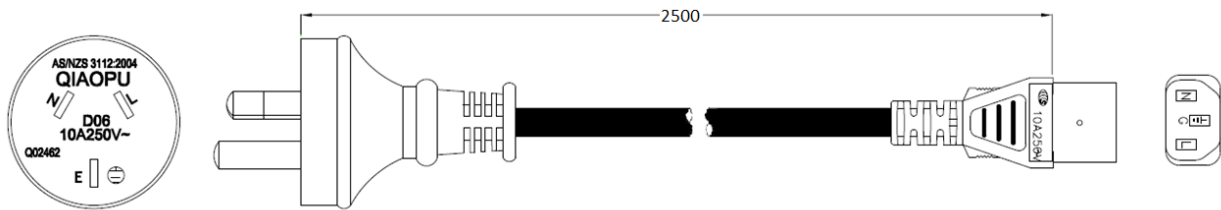

NOTE

Power cable uses water-proofed AMPHENOL connectors. It must keep pressing this Lock Button during pulling out the power plug.



Grounding:

The PowerCube-X1 modules are grounding based on metal direct touch between the module's surface and rack's surface. So it needn't grounding cables at all. If uses normal rack, it can remove the paint at the corresponding place. Or install a grounding cable to the grounding point of the modules.

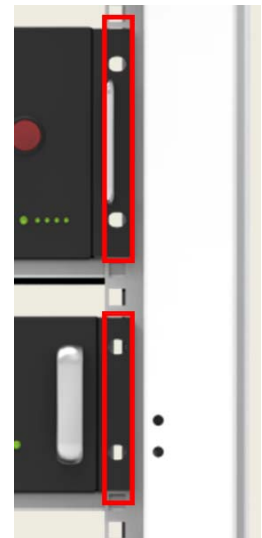
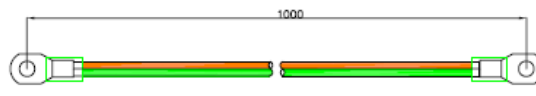

CAUTION

The rack/cabinet grounding goes through the connection with Metal base support or grounding cable through the stud screw at the bottom of the rack/cabinet. The connection is necessary.

3.4 Installation Location

Make sure that the installation location meets the following conditions:

- ◆ The area is completely water proof.
- ◆ The floor is flat and level.
- ◆ There are no flammable or explosive materials.

- ◆ The ambient temperature is within the range from 0°C to 50°C.
- ◆ The temperature and humidity is maintained at a constant level.
- ◆ There is minimal dust and dirt in the area.



CAUTION

If the ambient temperature is outside the operating range, the battery pack stops operating to protect itself. The optimal temperature range for the battery pack to operate is 0°C to 50°C. Frequent exposure to harsh temperatures may deteriorate the performance and life of the battery pack.

Installation

A. Put battery modules into cabinet and connect the cables:

- ① Connect the External Communication Cable, External Power Cable + and - and AC power cable from Inverter;
- ② Put the control module and the battery modules into the cabinet;
- ③ Drive the screws, to fasten each module on the rack;
- ④ Connect the cables between battery modules and the control module;

The cables' installation sequence is as followed diagram:

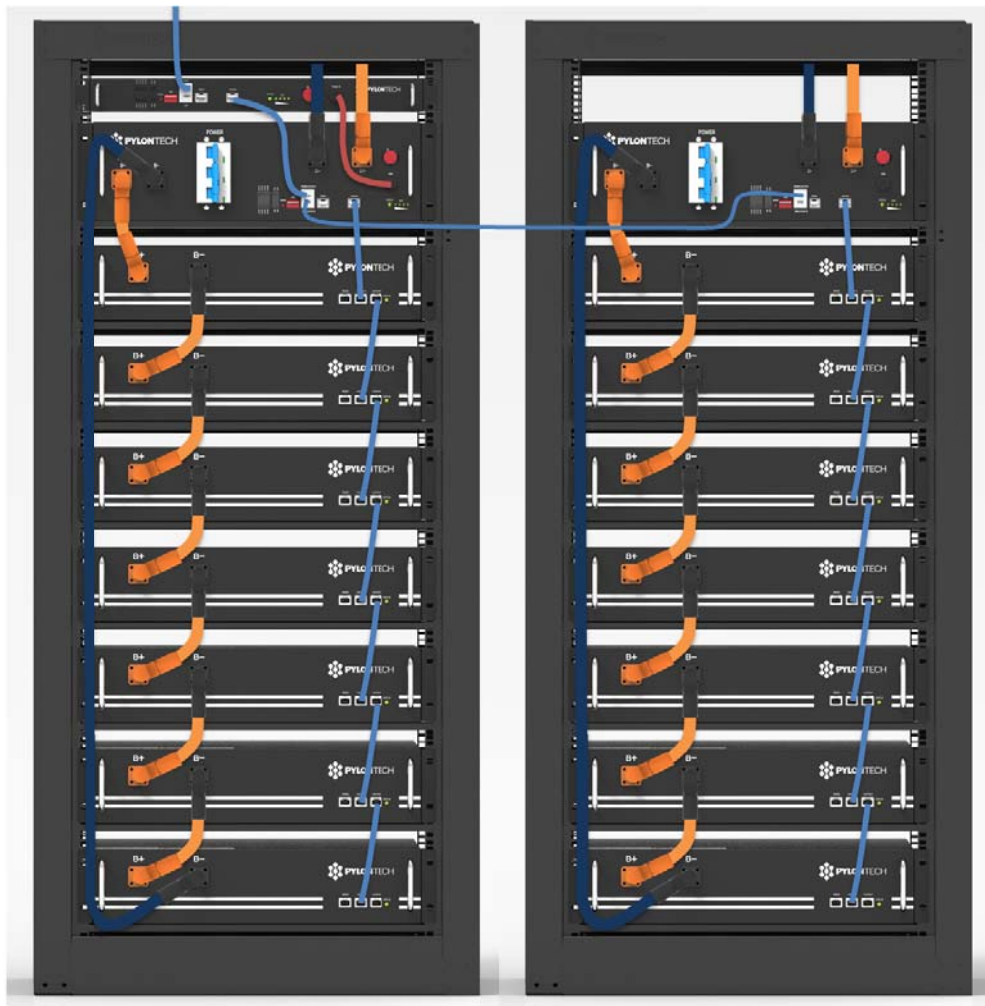

B. System turn On

Double check all the power cables and communication cables. Make sure the voltage of the Inverter is same level with the battery system.

(1) Switch battery system switch on.

All the control modules and the battery modules' green LED light (status and capacity) as below will be on:

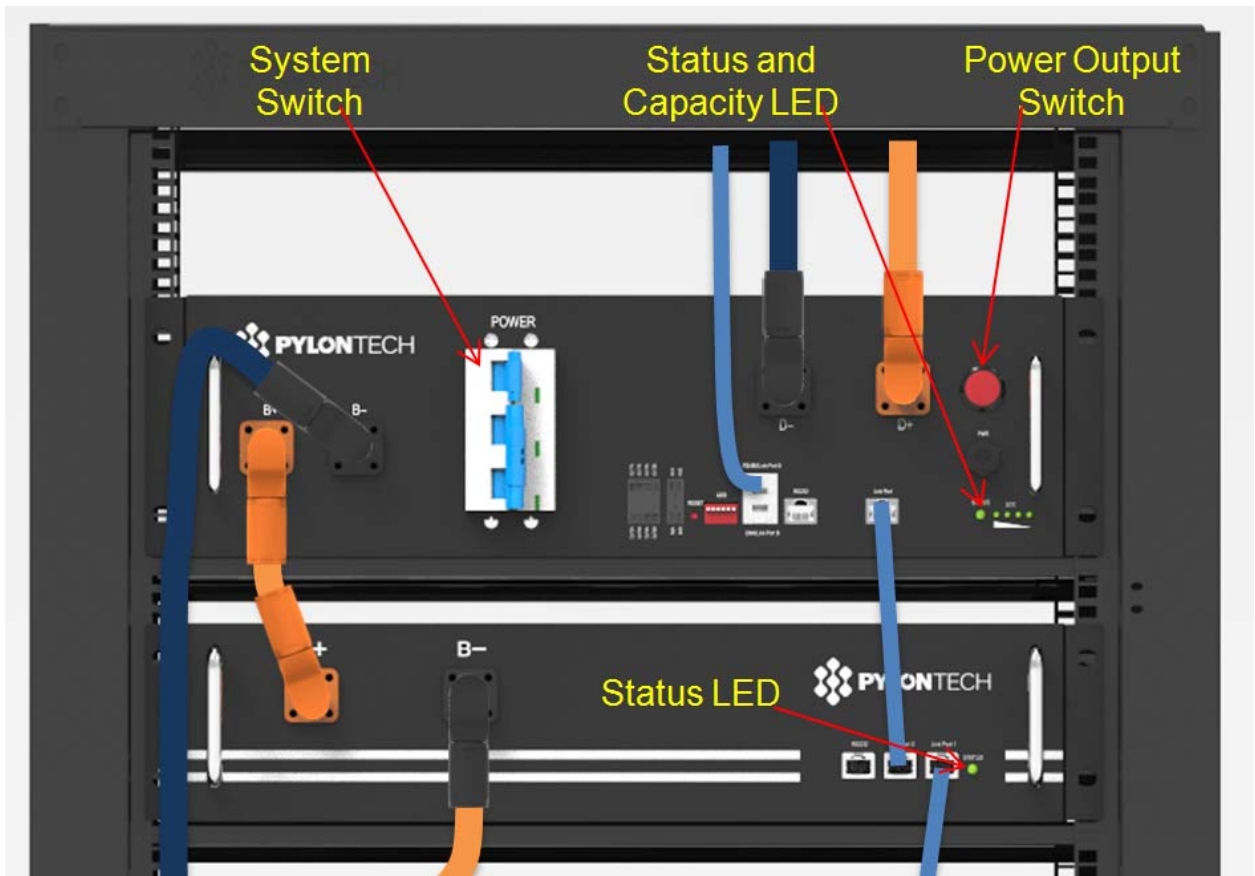

If all the LED light on as normal, which means the battery system is good and working.

(2) Check the battery system's working status on control module.

(3) Turns the power output switch on:

C. System turn off

(1) Turn off the System Switch.

(2) The Power Output Switch normally needn't switch off.

Caution:

Before change the battery module for service, must charge/discharge the replaced battery same voltage to the other in system battery modules. Otherwise the system need long time to do the balance for this replaced battery module.

NOTE

After installation, do not forget to register online for full warranty:

www.pylontech.com.cn/service/registration

5. Trouble Shooting Steps

- 1) If the system is turned on, and the status LED of Control Module is red, but the status LED of Battery Module is green. Please check the External Battery Communication Cable (CAN/RS485) connection is right or not.
- 2) If the system is turned on, and the status LED of Control Module is flashing in red, the battery system self check can't detected. Please check the Power Cables of Battery Module Serial Connection is right or not.
- 3) If the system is turned on, the status LED of Control Module and the status LED of Battery Module is orange. That's means some running condition is out of setting parameters' range. The battery system is not failure.
- 4) If the system is turned on, the status LED of Control Module is red, it means the system is in protection mode or has failure. If the status LED of Battery Module is also red (in protection mode or has failure), voltage, current, temperature protection are protection mode. In protection mode the system will release itself if the working environment goes back normal. If it caused by battery system failure, please shut the battery system off, and inform service staff.
- 5) If the battery system is in low capacity long time, please turn off the System Switch to avoid the battery empty to damage the cells.

6. Emergency Situations

1) Leaking Batteries

If the battery pack leaks electrolyte, avoid contact with the leaking liquid or gas. If one is exposed to the leaked substance, immediately perform the actions described below.

Inhalation: Evacuate the contaminated area, and seek medical attention.

Contact with eyes: Rinse eyes with flowing water for 15 minutes, and seek medical attention.

Contact with skin: Wash the affected area thoroughly with soap and water, and seek medical attention.

Ingestion: Induce vomiting, and seek medical attention.

2) Fire

NO WATER! Only dry powder fire extinguisher can be used; if possible, move the battery pack to a safe area before it catches fire.

3) Wet Batteries

If the battery pack is wet or submerged in water, do not let people access it, and then contact Pylontech or an authorized dealer for technical support.

4) Damaged Batteries

Damaged batteries are dangerous and must be handled with the utmost care. They are not fit for use and may pose a danger to people or property. If the battery pack seems to be damaged, pack it in its original container, and then return it to Pylontech or an authorized dealer.

NOTE

Damaged batteries may leak electrolyte or produce flammable gas. If such damage occurs, please contact Pylontechservice@pylontech.com.cn



Pylon Technologies Co., Ltd.

No. 73, Lane 887, Zu Chongzhi Road, Zhangjiang Hi-Tech Park Pudong,
Shanghai 201203, China



Pylon Technologies Co., Ltd.

No. 73, Lane 887, ZuChongzhi Road, Zhangjiang Hi-Tech Park
Pudong, Shanghai 201203, China

T+86-21-51317697 | F +86-21-51317698

Eservice@pylontech.com.cn

[Wwww.pylontech.com.cn](http://www.pylontech.com.cn)