

1

2

3

4

5

6

13187
(20007-005)
0.1mm Thick

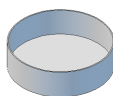
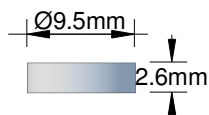

13077
(20007-010)
0.1mm Thick

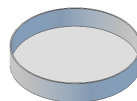
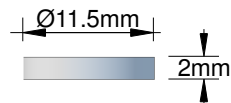

NCB158
0.1mm Thick

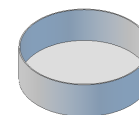
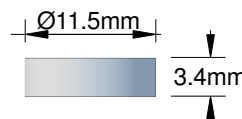

NCB158A
0.1mm Thick

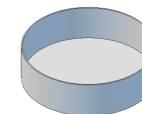
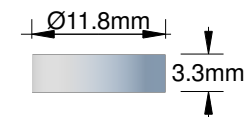

NCB133
0.1mm Thick

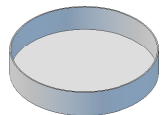
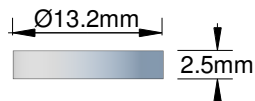

26127
(20007-075)
0.1mm Thick

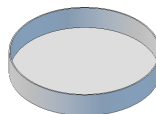
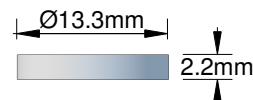

29657
(20007-019)
0.1mm Thick

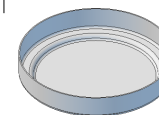
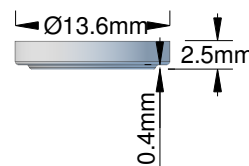

NCB003
0.1mm Thick

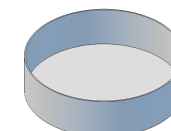
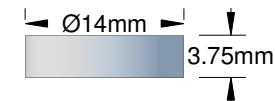

This drawing and the designs so represented are the copyright property of Master Instruments Pty Ltd. The drawing shall not be copied, loaned or issued without the express written permission of a duly authorised representative of Master Instruments Pty Ltd.

PACK VOLTAGE	-
PACK CAPACITY	-
NO. OF CELLS	-
NO. SERIES	-
NO. PARALLEL	-

STACKING CUPS									
-									
11/03/2016									

RevNo	Update	Dwg By	Chemistry	Page	Power	Sample	Jig	Charger	Checked By	Approved By
0		BM	-		-	-	-	-		

1

2

3

4

5

6

A

B

C

D

A

B

C

D

1

2

3

4

5

6

NCB129
0.1mm Thick

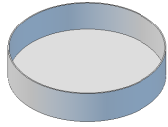
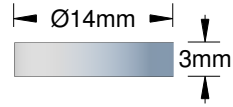

NCB165
0.1mm Thick

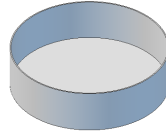
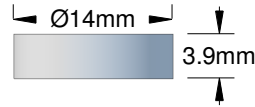

NCB277
0.1mm Thick

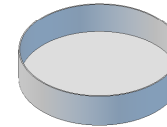
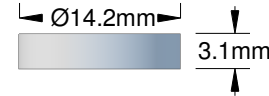

NCB284
0.1mm Thick

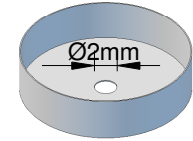
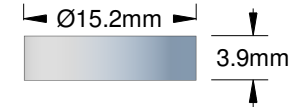

NCB055
0.1mm Thick

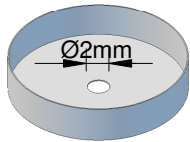
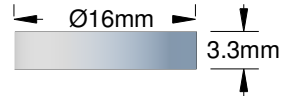

NCB216
0.1mm Thick

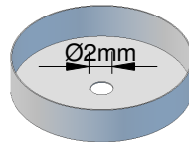
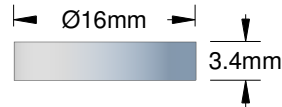

NCB137E
0.1mm Thick

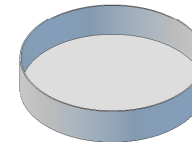
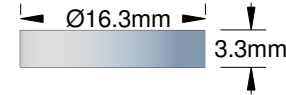

NCB087R
0.1mm Thick

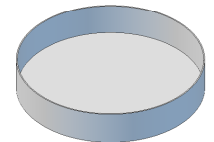
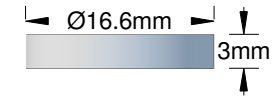

This drawing and the designs so represented are the copyright property of Master Instruments Pty Ltd. The drawing shall not be copied, loaned or issued without the express written permission of a duly authorised representative of Master Instruments Pty Ltd.

PACK VOLTAGE -		STACKING CUPS								-													
PACK CAPACITY -																							
NO. OF CELLS -		-				-				11/03/2016													
NO. SERIES -																							
NO. PARALLEL -		RevNo		Update		Dwg By		Chemistry		Page		Power		Sample		Jig		Charger		Checked By		Approved By	
0		BM		-		-		-		-		-		-		-		-		-		-	

1

2

3

4

5

6

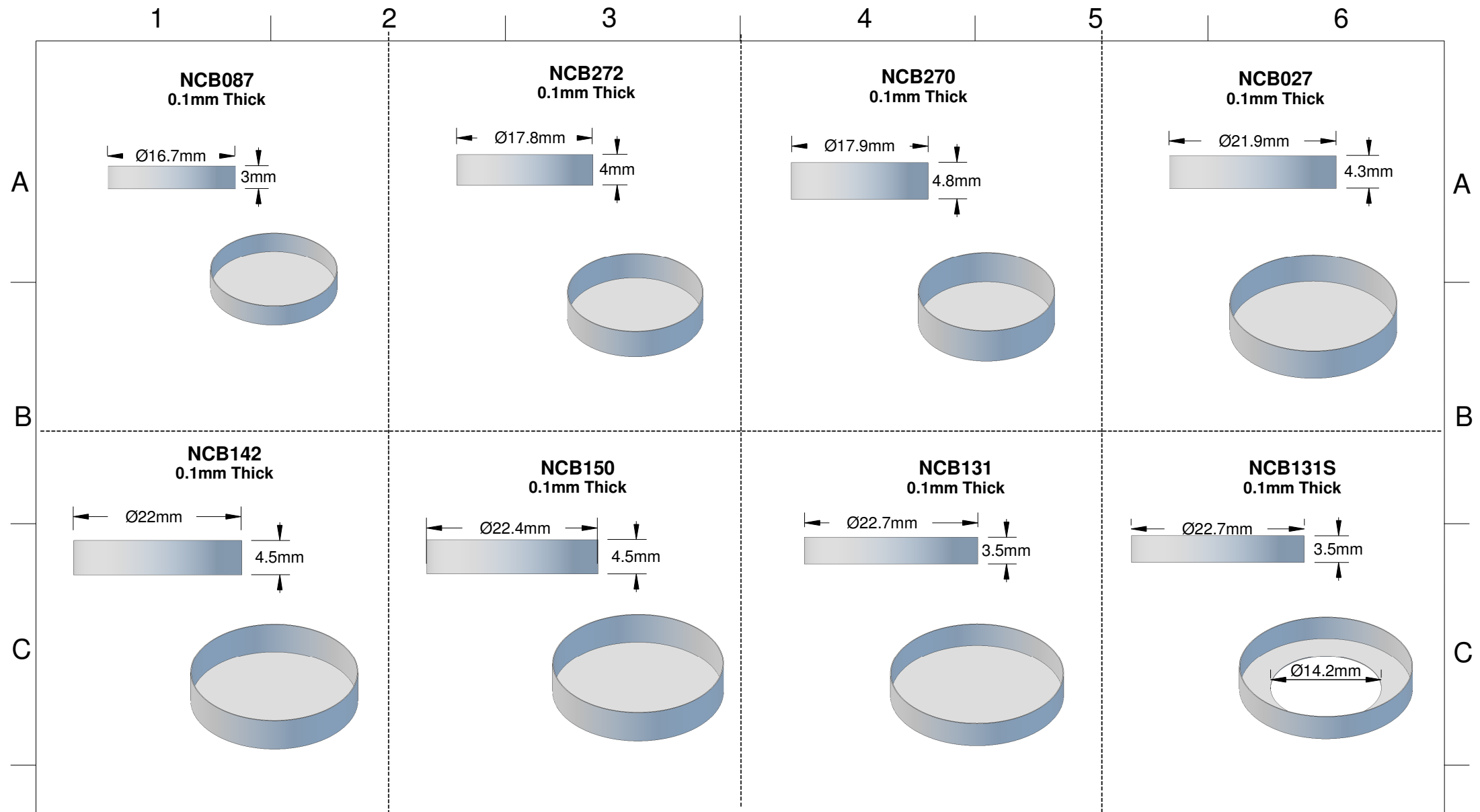

This drawing and the designs so represented are the copyright property of Master Instruments Pty Ltd. The drawing shall not be copied, loaned or issued without the express written permission of a duly authorised representative of Master Instruments Pty Ltd.

PACK VOLTAGE		-		STACKING CUPS						-	
PACK CAPACITY		-									
NO. OF CELLS		-		-						11/03/2016	
NO. SERIES		-									
NO. PARALLEL		-		-						-	
RevNo	Update	Dwg By	Chemistry								
0		BM	-		-	-	-	-			

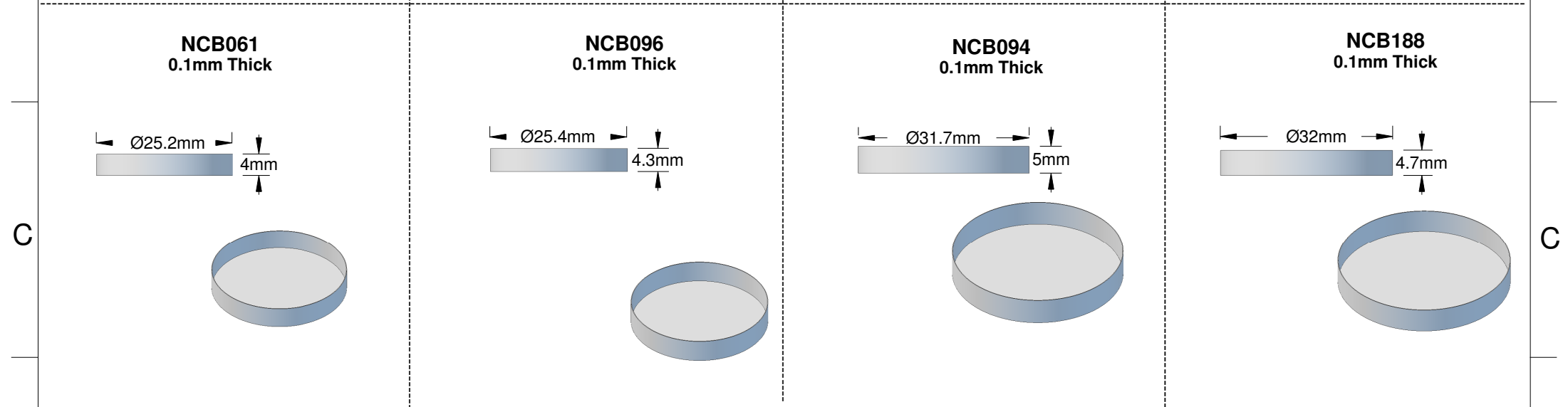
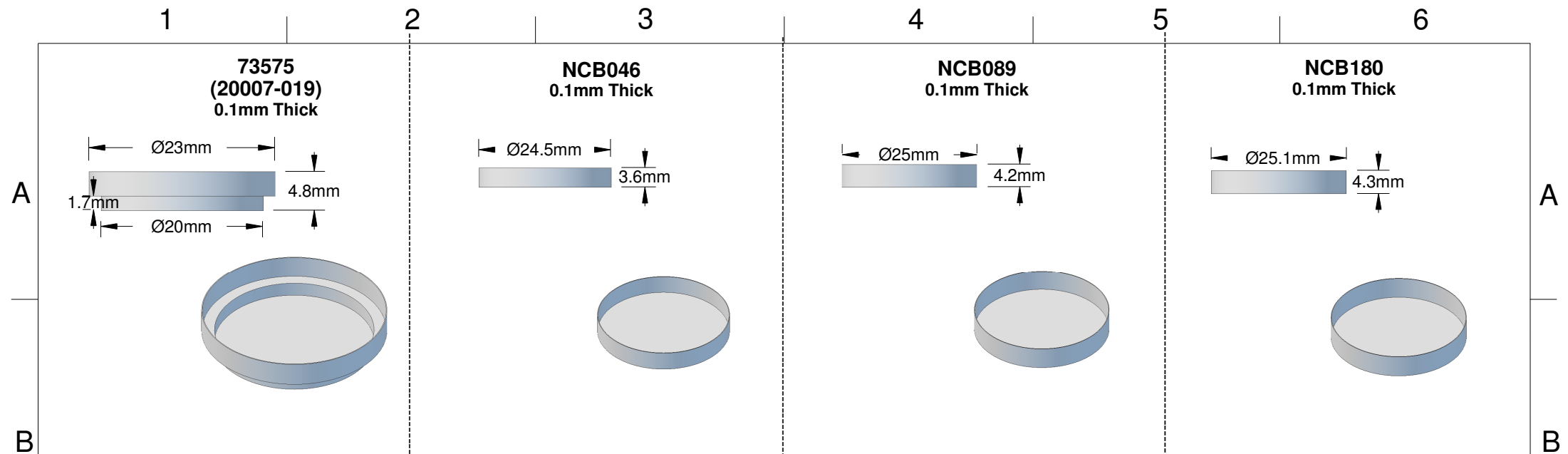



This drawing and the designs so represented are the copyright property of Master Instruments Pty Ltd. The drawing shall not be copied, loaned or issued without the express written permission of a duly authorised representative of Master Instruments Pty Ltd.

Form 024_Rev3_07.04.15

PACK VOLTAGE -		STACKING CUPS								-													
PACK CAPACITY -																							
NO. OF CELLS -		-				-				11/03/2016													
NO. SERIES -																							
NO. PARALLEL -		RevNo		Update		Dwg By		Chemistry		Page		Power		Sample		Jig		Charger		Checked By		Approved By	
		0		BM		-		-		-		-		-		-							

1

2

3

4

5

6

NCB094F
0.1mm Thick

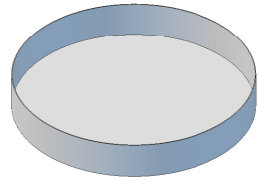
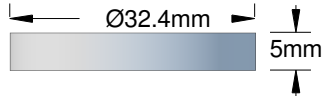

NCB271
0.1mm Thick

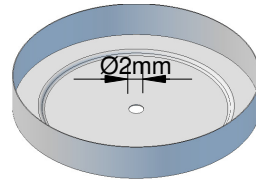
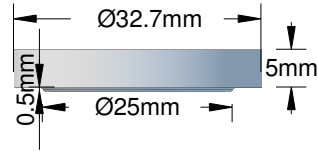

411135-168
(20007-035)
0.1mm Thick

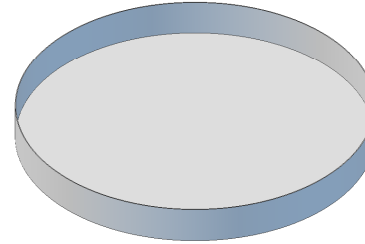
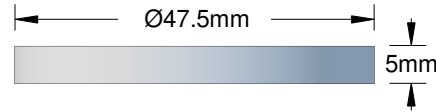

NCB331
0.15mm Thick

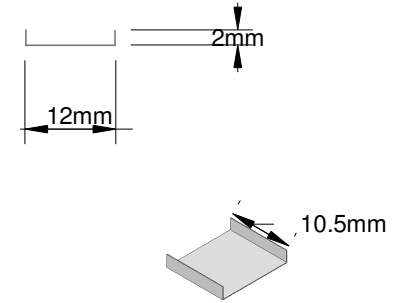

NCB329
0.15mm Thick

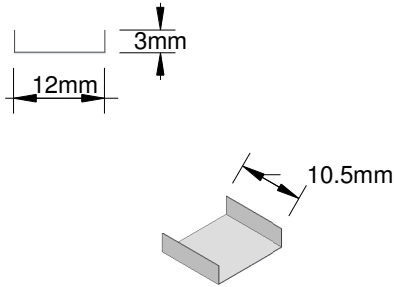

This drawing and the designs so represented are the copyright property of Master Instruments Pty Ltd. The drawing shall not be copied, loaned or issued without the express written permission of a duly authorised representative of Master Instruments Pty Ltd.

PACK VOLTAGE -		STACKING CUPS								-													
PACK CAPACITY -																							
NO. OF CELLS -		-				-				11/03/2016													
NO. SERIES -																							
NO. PARALLEL -		RevNo		Update		Dwg By		Chemistry		Page		Power		Sample		Jig		Charger		Checked By		Approved By	
		0		BM		-						-		-		-							

1

2

3

4

5

6

A

B

C

D

A

B

C

D