

Panasonic Batteries

Lithium Ion Batteries Technical Handbook '99

International English Version



PDF File Technical Handbook

Copyright 1999 Matsushita Battery Industrial Co., Ltd. All rights Reserved. No part of this technical handbook pdf file may be changed, altered, reproduced in any form or by any means without the prior written permission of Matsushita Battery Industrial Co., Ltd.

NOTICE TO READERS

It is the responsibility of each user to ensure that each battery application system is adequately designed safe and compatible with all conditions encountered during use, and in conformance with existing standards and requirements. Any circuits contained herein are illustrative only and each user must ensure that each circuit is safe and otherwise completely appropriate for the desired application.

This literature contains information concerning cells and batteries manufactured by Matsushita Battery Industrial Co., Ltd. This information is generally descriptive only and is not intended to make or imply any representation guarantee or warranty with respect to any cells and batteries. Cell and battery designs are subject to modification without notice. All descriptions and warranties are solely as contained in formal offers to sell or quotations made by Matsushita Battery Industrial Co., Ltd., Panasonic Sales Companies and Panasonic Agencies.

Lithium Ion Batteries: Table of Contents

Notes and Precautions	2
Safety Precautions for the Lithium Ion Battery Pack	4
Overview of Lithium Ion Batteries	6
Features of Lithium Ion Batteries	8
Overcharge/Overdischarge/Overcurrent Safety Circuits	9
How to Charge the Batteries	11
• Flowchart for Charging the Lithium Ion Battery Packs	
Glossary of Terminology for Lithium Ion Batteries	13
Specification Summary Table	14
Individual Data Sheets	15
Battery Pack Specification Checklist	26
Charger Specification Checklist	27

NOTES AND PRECAUTIONS

• Safety Precautions for the Lithium Ion Battery Pack

Use of Lithium Ion Batteries and the Design of Equipment That Uses These Batteries

In general, lithium ion batteries are used in battery packs that contain both lithium ion batteries and battery protection circuits. Both items are sealed in a container made of a material such as resin so that the battery pack cannot be easily disassembled.

1. Charging the Batteries

The “constant voltage/constant current” method is used to charge lithium ion batteries. (See Figure below.)

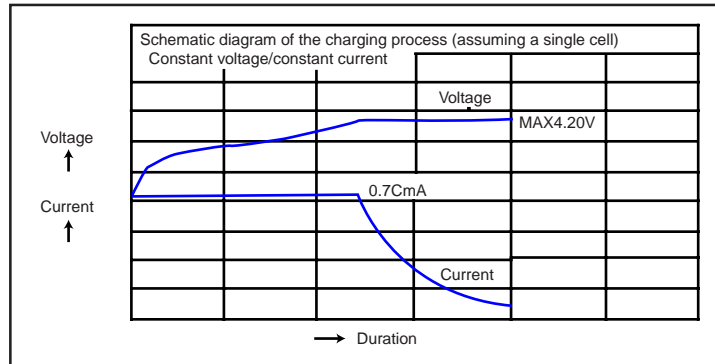

(1) Charge Voltage

The maximum voltage is 4.2 V x the number of cells connected in series.

(2) Charge Current

We recommend 0.7 CmA.

When the voltage per cell is 2.9V or less, charge using a charge current of 0.1CmA or less. (Contact Panasonic for information regarding pulse charging.)

(3) Charge Temperature

The batteries should be charged at temperatures between 0°C and 45°C.

(4) Reverse-polarity Charging

Verify the polarity of the batteries before charging to insure that they are never charged with the polarity reversed.

2. Discharging the Batteries

(1) Discharge Current

The current should be maintained at 1.0 CmA or less (Consult Panasonic if you plan to discharge the batteries with a current in excess of 1.0 CmA).

(2) Discharge Temperature

The batteries should be discharged at a temperature between -10°C and +60°C.

(Consult Panasonic if you plan to discharge the batteries at temperatures less than -10°C.)

(3) Discharge Termination Voltage

Avoid discharging at voltages less than 3.0 V per cell. Overdischarge can damage the performance of the battery. Equip the unit with a mechanism to prevent overdischarge, especially in situations where the user may forget to turn the equipment off.

3. Equipment Design

(1) Installing Battery Packs in the Equipment

To avoid damage to the battery pack, make sure that the battery pack is positioned away from heat sources in the equipment or in the battery charger.

(2) Mechanisms to Prevent Dropping

Be sure to use a battery pack lock mechanism to prevent the battery pack from being ejected when the equipment is dropped or receives a sudden impact.

(3) Preventing Short Circuits and Reversed Connections

Use a terminal structure that makes it unlikely that the terminals will be shorted by metallic necklaces, clips, hairpins, etc. Structure the battery and the terminals to the battery in such a way that the battery pack cannot be put in backwards when installed in the charger or the equipment.

(4) Inclusion in Other Equipment

If the battery is built into other equipment, use caution to strictly avoid designing airtight battery compartments.

(5) Terminal Materials in the External Equipment

Use materials that are highly resistant to corrosion (such as nickel or nickel-coated copper). If contact resistance is an issue, we recommend that you use contact plating (such as gold plating) on the terminals.

4. Storing the Batteries

The batteries should be stored at room temperature, charged to about 30 to 50% of capacity. We recommend that batteries be charged about once per year to prevent overdischarge.

5. Use of the Batteries

See the section on "Safety Precautions for the Lithium Ion Battery Pack."

6. Other

The Chemical Reaction

Because batteries utilize a chemical reaction they are actually considered a chemical product. As such, battery performance will deteriorate over time even if stored for a long period of time without being used. In addition, if the various usage conditions such as charge, discharge, ambient temperature, etc. are not maintained within the specified ranges the life expectancy of the battery may be shortened or the device in which the battery is used may be damaged by electrolyte leakage. If the batteries cannot maintain a charge for long periods of time, even when they are charged correctly, this may indicate it is time to change the battery.

7. Please Note

The performance and life expectancy of batteries depends heavily on how the batteries are used. In order to insure safety, be sure to consult with Panasonic in advance regarding battery charging and discharging specifications and equipment structures when designing equipment that includes these batteries.

Please Note:

Panasonic assumes no liability for problems that occur when the Notes and Precautions for use listed above are not followed.

• Safety Warnings

1. When Using the Battery

WARNING

- (1) Misusing the battery may cause the battery to get hot, explode, or ignite and cause serious injury. Be sure to follow the safety rules listed below:
 - Do not place the battery in fire or heat the battery.
 - Do not install the battery backwards so that the polarity is reversed.
 - Do not connect the positive terminal and the negative terminal of the battery to each other with any metal object (such as wire).
 - Do not carry or store the batteries together with necklaces, hairpins, or other metal objects.
 - Do not pierce the battery with nails, strike the battery with a hammer, step on the battery, or otherwise subject it to strong impacts or shocks.
 - Do not solder directly onto the battery.
 - Do not expose the battery to water or salt water, or allow the battery to get wet.
- (2) Do not disassemble or modify the battery. The battery contains safety and protection devices which, if damaged, may cause the battery to generate heat, explode or ignite.
- (3) Do not place the battery on or near fires, stoves, or other high-temperature locations. Do not place the battery in direct sunshine, or use or store the battery inside cars in hot weather. Doing so may cause the battery to generate heat, explode, or ignite. Using the battery in this manner may also result in a loss of performance and a shortened life expectancy.

CAUTION

- (1) If the device is to be used by small children, the caregiver should explain the contents of the user's manual to the children. The caregiver should provide adequate supervision to insure that the device is being used as explained in the user's manual.
- (2) When the battery is worn out, insulate the terminals with adhesive tape or similar materials before disposal.
- (3) Immediately discontinue use of the battery if, while using, charging, or storing the battery, the battery emits an unusual smell, feels hot, changes color, changes shape, or appears abnormal in any other way. Contact your sales location or Panasonic if any of these problems are observed.
- (4) Do not place the batteries in microwave ovens, high-pressure containers, or on induction cookware.
- (5) In the event that the battery leaks and the fluid gets into one's eye, do not rub the eye. Rinse well with water and immediately seek medical care. If left untreated the battery fluid could cause damage to the eye.

2. While Charging

WARNING

- (1) Be sure to follow the rules listed below while charging the battery. Failure to do so may cause the battery to become hot, explode, or ignite and cause serious injury.
 - When charging the battery, either use a specified battery charger or otherwise insure that the battery charging conditions specified by Panasonic are met.
 - Do not attach the batteries to a power supply plug or directly to a car's cigarette lighter.
 - Do not place the batteries in or near fire, or into direct sunlight. When the battery becomes hot, the built-in safety equipment is activated, preventing the battery from charging further, and heating the battery can destroy the safety equipment and can cause additional heating, breaking, or ignition of the battery.
- (2) Do not continue charging the battery if it does not recharge within the specified charging time. Doing so may cause the battery to become hot, explode, or ignite.

CAUTION

The temperature range over which the battery can be charged is 0°C to 45°C. Charging the battery at temperatures outside of this range may cause the battery to become hot or to break. Charging the battery outside of this temperature range may also harm the performance of the battery or reduce the battery's life expectancy.

3. When Discharging the Battery

WARNING

Do not discharge the battery using any device except for the specified device. When the battery is used in devices aside from the specified device it may damage the performance of the battery or reduce its life expectancy, and if the device causes an abnormal current to flow, it may cause the battery to become hot, explode, or ignite and cause serious injury.

CAUTION

The temperature range over which the battery can be discharged is -10°C to 60°C. Use of the battery outside of this temperature range may damage the performance of the battery or may reduce its life expectancy.

To insure the safe use of this battery, contact Panasonic when designing a device that uses this battery.

OVERVIEW OF LITHIUM ION BATTERIES

Meeting the Needs of Portable Electronic Devices:

Lithium Ion Batteries



• Overview

Panasonic lithium ion batteries, products of Panasonic's long experience with batteries and leading-edge battery technology, are excellent sources for high-energy power in a variety of portable devices, such as portable computers and cellular phones. Light weight and boasting high voltage ratings (3.7 V), these high-energy density batteries provide a variety of features that will contribute to the weight reduction and downsizing of portable products.

• Structure

The lithium ion battery has a three-layer, coiled structure within its case. These three layers are comprised of a positive electrode plate (made with lithium cobalt oxide as its chief active ingredient), a negative electrode plate (made with a specialty carbon as its chief active ingredient), and a separator layer.

The battery is equipped with a variety of measures to insure safety, along with an anti-explosion valve that releases gas if the internal pressure exceeds a specific value, thereby preventing the battery from exploding.

• Safety

Panasonic's lithium ion batteries (CGR17500, CGR17670HC, CGR18650H, CGP30486, CGP345010, and CGP34506) have obtained UL1642 approval.

The Structure of Lithium Ion Batteries (Cylindrical)

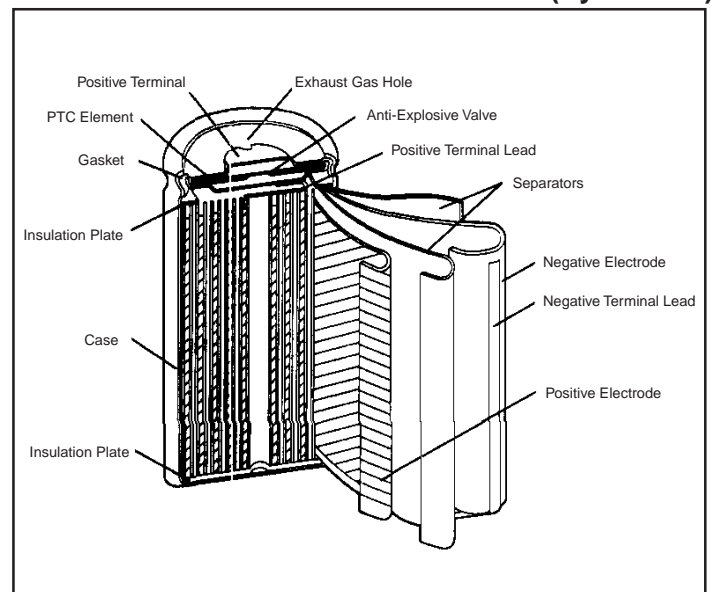

OVERVIEW THE LITHIUM ION BATTERIES - CONTINUED

• Battery Reaction

The lithium ion battery makes use of lithium cobalt oxide (which has superior cycling properties at high voltages) as the positive electrode and a highly-crystallized specialty carbon as the negative electrode. It uses an organic solvent, optimized for the specialty carbon, as the electrolytic fluid.

The chemical reactions for charge and discharge are as shown below:

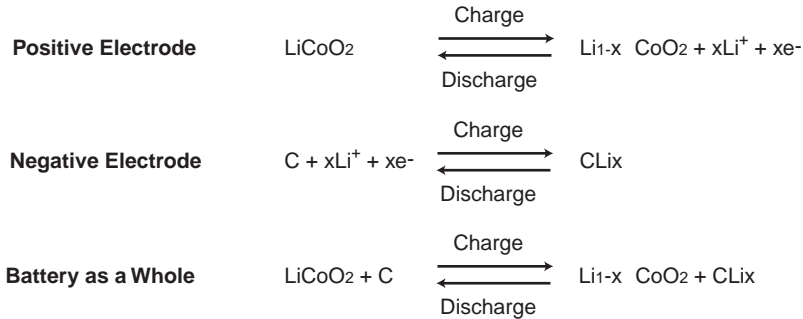

The principle behind the chemical reaction in the lithium ion battery is one where the lithium in the positive electrode lithium cobalt oxide material is ionized during charge, and moves from layer to layer in the negative electrode. During discharge, the ions move to the positive electrode and return to the original compound.

Schematic Diagram of the Chemical Reaction of the Lithium Ion Battery

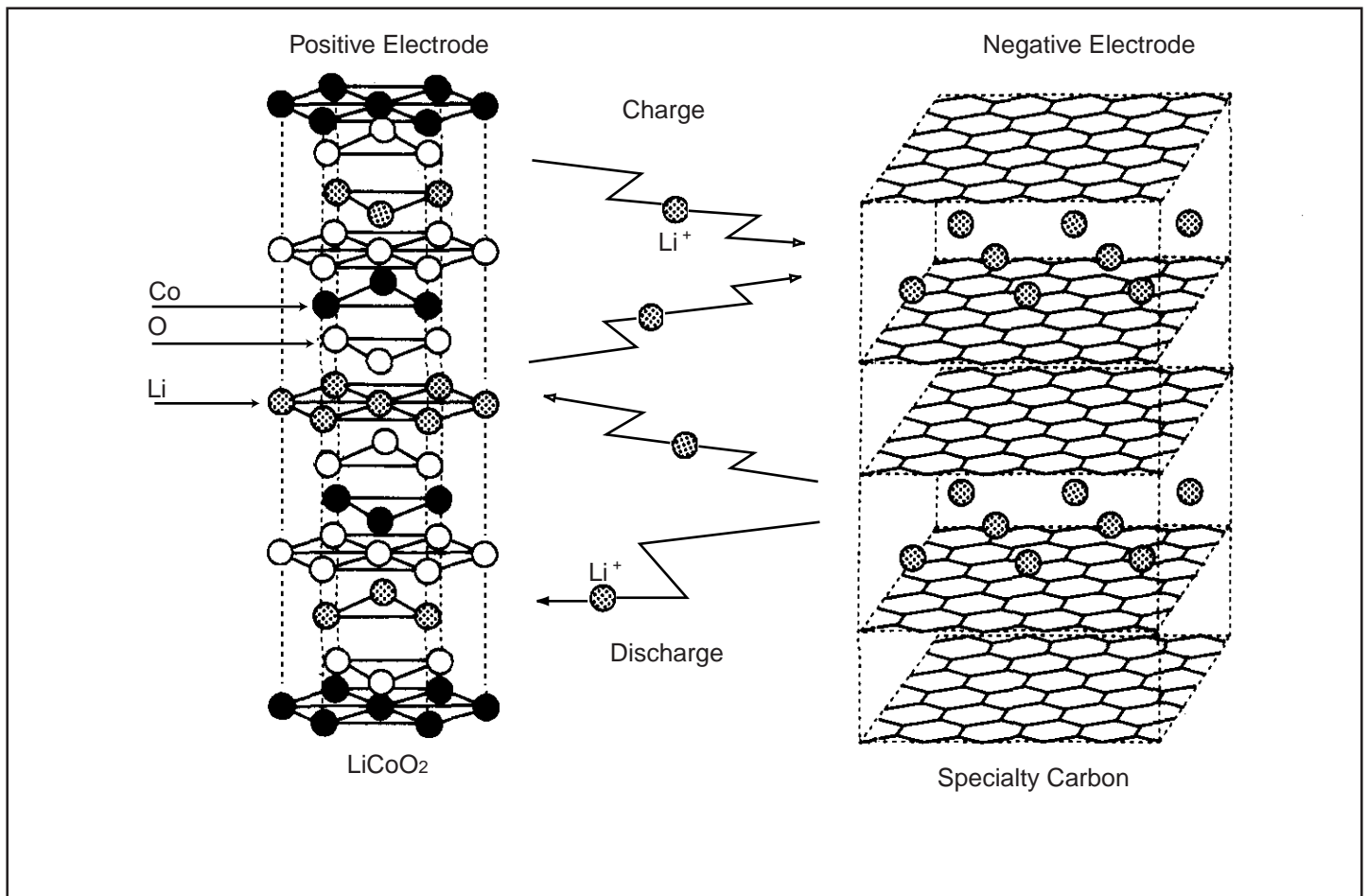

FEATURES OF THE LITHIUM ION BATTERIES

• High Energy Density

Because the lithium ion batteries are high voltage/light weight batteries, they boast a higher energy density than rechargeable nickel cadmium (Ni-Cd) batteries or nickel metal hydride (Ni-MH) batteries.

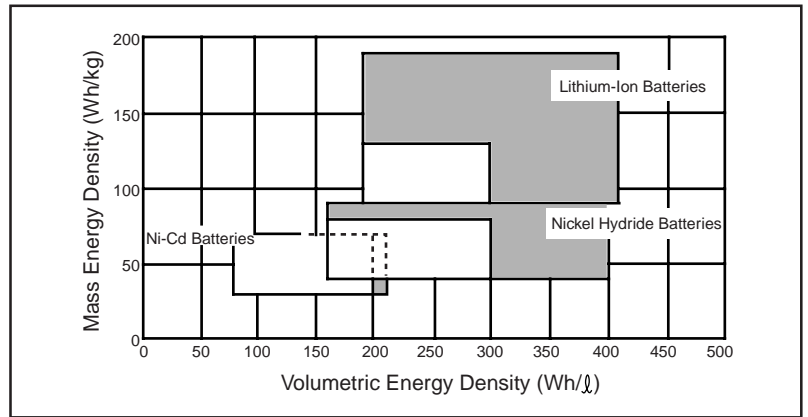

• High Voltage

Lithium ion batteries produce 3.7 volts, approximately three times the voltage of rechargeable Ni-Cd batteries or Ni-MH batteries. This will make it possible to make smaller, lighter equipment.

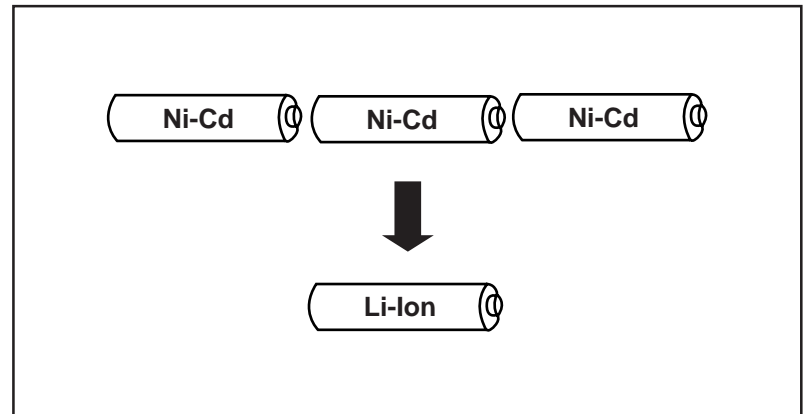

• No Memory Effect

Lithium ion batteries have none of the memory effects seen in rechargeable Ni-Cd batteries ("memory effect" refers to the phenomenon where the apparent discharge capacity of a battery is reduced when it is repetitively discharged incompletely and then recharged).

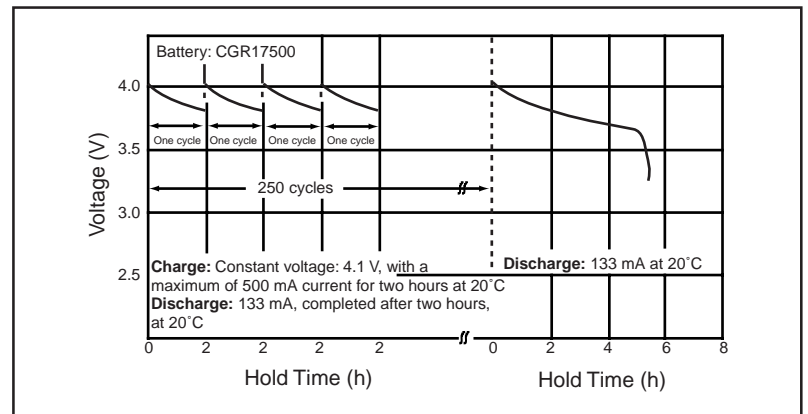

• Flat Discharge Voltage

The use of the specialty carbon creates an extremely flat discharge voltage profile, allowing the production of stable power throughout the discharge period of the battery.

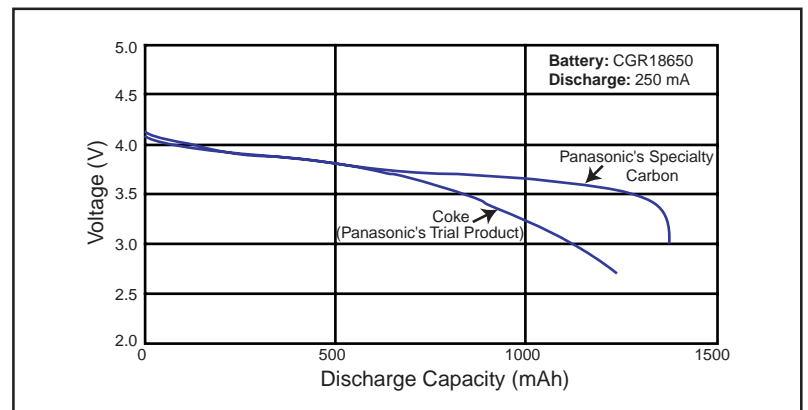

OVERCHARGE/OVERDISCHARGE/OVERCURRENT SAFETY CIRCUITS

• The Functions of the Safety Circuits (Typical Functions)

The voltages listed below are typical values and are not guaranteed. The charge voltage varies according to model number.

1. The Overcharge Safety Function

The charge stops when the voltage per cell rises above 4.30 ± 0.05 V.
The charge restarts when the voltage per cell falls below 4.00 ± 0.15 V.

2. The Overdischarge Safety Function

The discharge stops when the voltage per cell falls below 2.3 ± 0.1 V.
The discharge restarts when the voltage per cell rises above 3.0 ± 0.15 V.

3. The Overcurrent Safety Function

The discharge is stopped when the output terminals are shorted.
The discharge restarts when the short is removed.

• Reference Example of the Safety Circuits

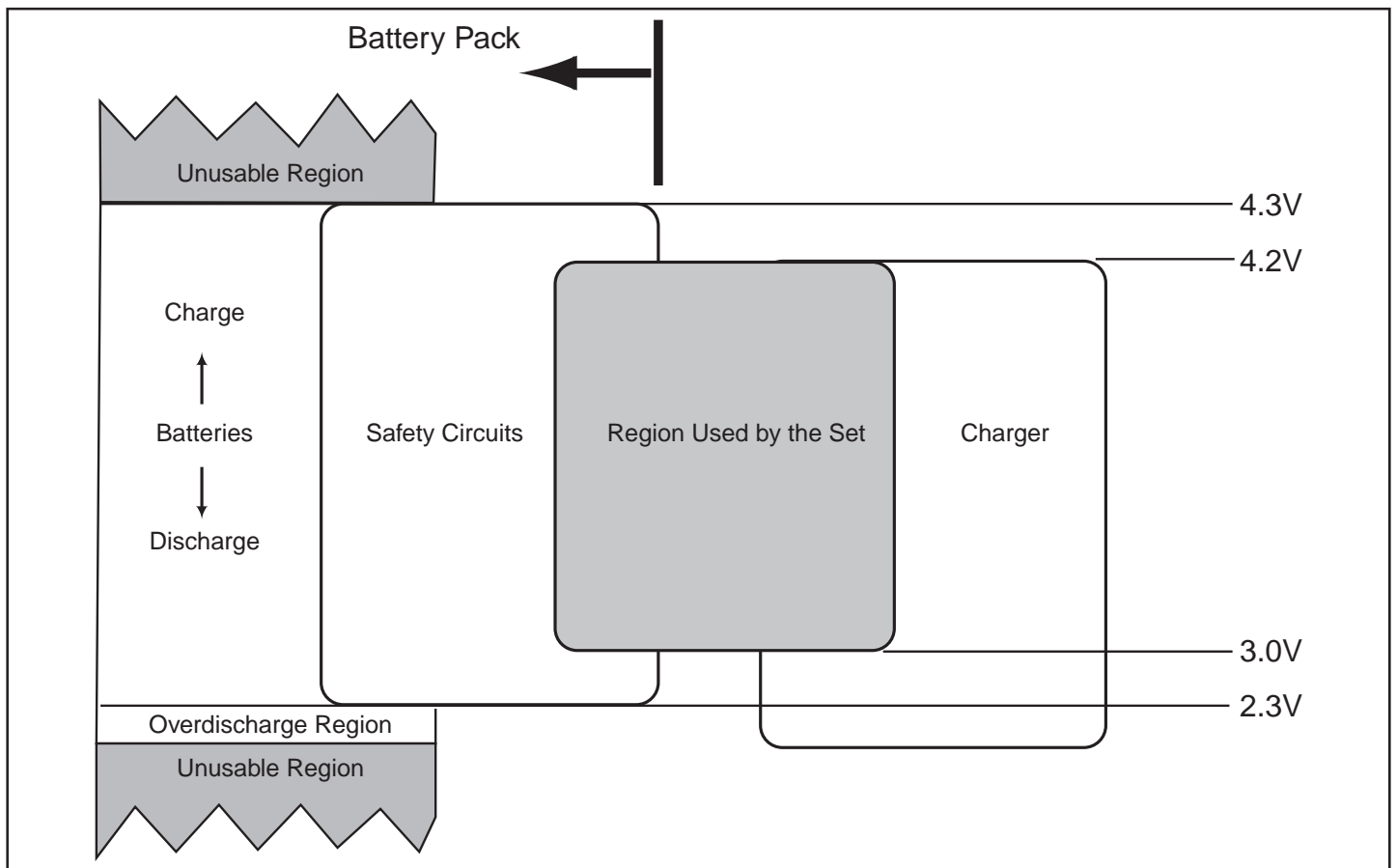

- The safety circuits in the diagram above are for overcharging, overdischarging, and overcurrent for a single cell battery pack. Please contact Panasonic when two or more cells are connected or when actually using this or other circuits.

• Battery Pack Block Diagram (Reference Example)

The diagram below shows a diagram of a lithium ion battery pack. The battery pack includes the batteries, the safety circuits, and thermistors.

1. The Safety Circuits

1.1 The Controller IC

The controller IC measures the voltage for each cell (or for each parallel battery block) and shuts off a control switch to either prevent overcharging (if the voltage exceeds the specified voltage range) or to prevent overdischarging (if the voltage falls below the specified voltage range). Moreover, the voltage of the control switch is measured on both ends and in order to prevent overcurrent, both control switches are shut off if the voltage exceeds specifications.

1.2 The Control Switches

The control switches usually comprise FET structures, and they turn off the charge or discharge depending on the output of the controller IC.

1.3 The Temperature Fuse (Reference Materials)

If the control switches experience abnormal heating, this fuse cuts off the current (non-restoring).

2. The Thermistors

The thermistors are included in order to accurately measure the battery temperature within the lithium ion battery packs. The battery or charger measures the resistance value of the thermistor between the T-terminal and the negative terminal and during the charging process, controls the charge current along with controlling until the charge is terminated.

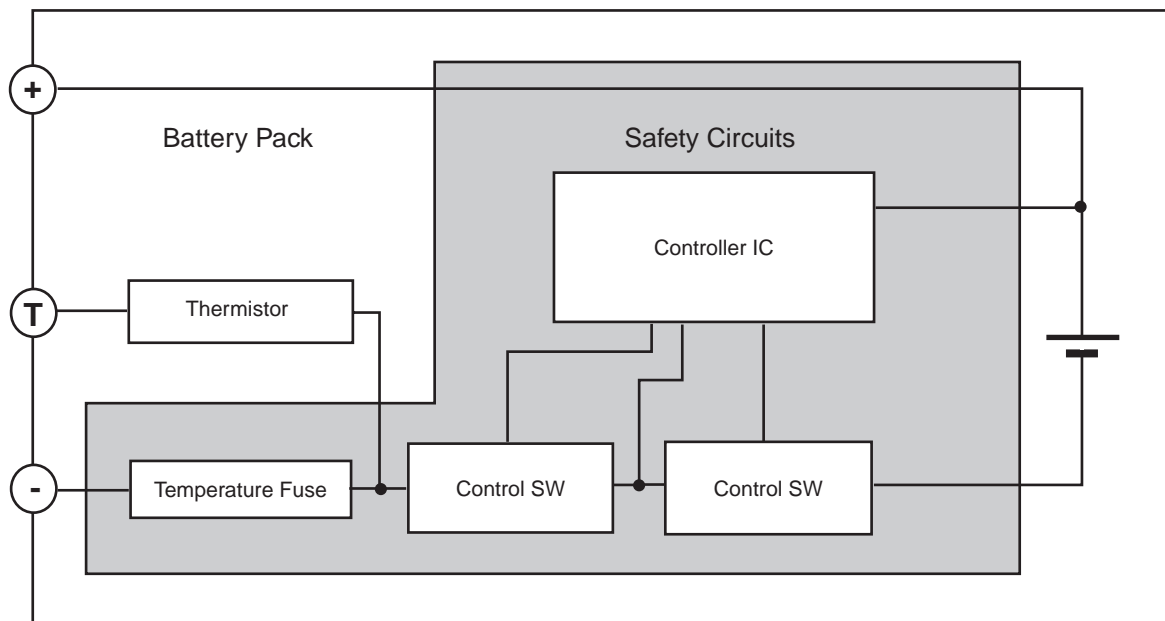

- The battery pack must be equipped with a noise filter at the voltage detectors in the block diagram above to insure that outside noise does not cause the battery to malfunction. Please check against the final product.
- Please include a total charge timer and a charge completion timer on the charging circuit in order to provide redundant safety control.

HOW TO CHARGE THE BATTERIES

We recommend the following charging process to insure the optimal performance of the lithium ion battery.

• **Applicable Battery Packs**

The discussion below assumes that the battery packs are equipped with internal safety circuits to prevent overcharging and overdischarging, and assumes that the battery is a single cell battery.

• **Charging Method**

The lithium ion battery can be charged by the constant voltage/constant current charging method found in the “Notes and Precautions” at the beginning of this document. (See page 2, “Notes and Precautions”)

• **Functions and Performance Required in the Charger (Recommendations)**

(1) **Charge Voltage**

The voltage between the charging terminals should be no more than 4.20 V (Set this at 4.20 V (max) after taking into account fluctuations in power supply voltages, temperature deviations, etc.). The charge voltage varies according to model number. For example, please charge CGP30486 at 4.10 volt.

(2) **Charge Current**

The reference charge current should be 0.7 CmA.

(3) **Ambient Temperature of the Battery Pack During Charge**

0°C to 45°C (Consult Panasonic if the battery pack is to be used outside of this temperature range).

(4) **Low-Voltage Battery Pack Charge**

When the voltage per cell is 2.9 V or less, charge using a charge current of 0.1 CmA or less.

(5) **Termination of Charging**

The system will determine that the battery is full by detecting the charge current.

Stop charging once the current has reached 0.1 CmA to 0.07 CmA. Note that there will be some degree of variation for each individual battery.

(6) **Charge Timer**

A total charge timer and a charge completion timer should be included.

(7) **Countermeasures for Battery Problems**

Select an overvoltage guard in the power supply so that there will be no excessive voltage applied to the battery even if there is a problem with the power supply.

- The discussion above assumes a single cell battery. If two or more cells will be used or if there are other situations, please consult with Panasonic.

Lithium Ion Battery Pack Charge Flowchart (Example)

Reference example of charging a single-cell lithium ion battery pack

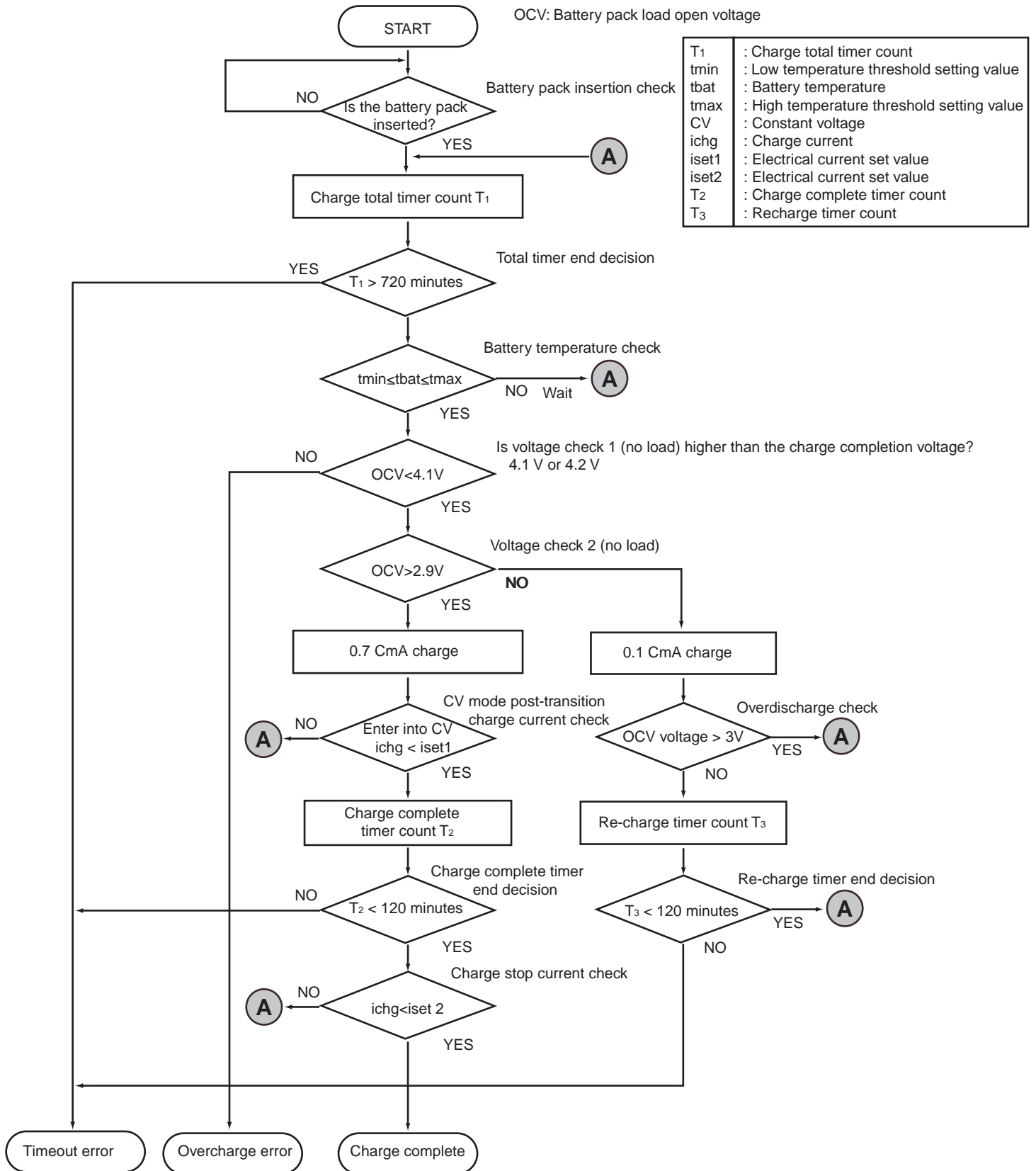

GLOSSARY OF TERMINOLOGY FOR LITHIUM ION BATTERIES

• Words Relating to the Characteristics of Batteries

Term	Definition
Energy Density	The amount of energy that can be produced per unit mass or per unit volume. Energy density is expressed in units of Wh/kg, Wh/l, etc.
Overcharge	Continued charging after the battery has reached a fully charged state. Generally charging more than necessary is unsafe and will have a harmful influence on the performance of the battery.
Overdischarge	Discharge of the battery below the established ending voltage.
Nominal Voltage	The voltage that is used as the battery voltage listed on the battery.
Cycle Life Characteristics	An attribute that indicates the time it takes per charge and discharge cycle when the battery is repetitively charged and discharged under specified parameters.
Time Ratio (C)	This metric is used to indicate the magnitude of the electrical current during charge or discharge. It is indicated in terms of a multiple of a value that indicates the capacity of the battery, and the value is expressed in units of electrical current. Generally the electrical current for charge or discharge is expressed in terms of a multiplier of C. For example, if the capacity is 1500 mAh, we have the following: $0.1\text{ C} = 0.1 \times 1500\text{ mA} = 150\text{ mA}$ $0.2\text{ C} = 0.2 \times 1500\text{ mA} = 300\text{ mA}$
Self Discharge	The amount to which the capacity of the battery is reduced without there being any current discharged through an external circuit.
Ending Voltage	The voltage that indicates the limit at which to stop the electrical discharge. This voltage roughly corresponds to the limit for use in practical applications.
Amount of Charge	This is the amount of electricity that is used in charging the battery. When there is the specified current during charge, this is the integral of the current value over the charging time. The units are ampere hours (Ah).
High Current Discharge	This refers to a discharge that has a large electrical current relative to the capacity of the battery. This is also known as "high rate discharge."
Standard Capacity	The standard value for the amount of electricity that can be used from a completely charged battery at the standard temperature, with a standard discharge current to the ending voltage. The units are ampere hours (Ah).
Fresh Battery	A "fresh battery" refers to a battery that has been charged and discharged five or less times within one month of manufacturing.
Capacity	This is the electrical ability of the battery. Normally this refers to ampere hours of capacity, and the units are either Ah or C (coulombs).
Capacity Retention Ratio	If the standard capacity is indexed to 100, this is the capacity ratio when the battery is first discharged (under specified conditions) after it has been stored for a specified period of time.
Capacity Recovery Ratio	If the standard capacity is indexed to 100, this is the maximum capacity ratio that can be obtained after repetitively charging and discharging the battery under specified conditions after it has been stored a specific period of time.
Fluid Leakage	This refers to the leakage of electrolytic fluid to the outer surface of the battery.

SPECIFICATION SUMMARY TABLE

Specifications

Shape	Model Number	Nominal Voltage (v)	Typical Capacity* (mAh)	Diameter / Width (mm)	Height (mm)	Thickness (mm)	Approx. Weight (g)
Cylindrical	CGR17500	3.7	830	17.0 ⁺⁰ _{-.10}	49.5 ± 0.5	---	25
	CGR17670HC		1250		66.7 ± 0.3	---	35
	CGR18650H		1500	18.3 ± 0.5	64.7 ± 0.3	---	40
Prismatic NEW	CGP30486		630**	29.8 ± 0.3	47.5 ± 0.5	6.4 ± 0.3	23
	CGP34506		875	33.8 ± 0.3	49.5 ± 0.5	6.5 ± 0.3	29
	CGP345010		1400	34.0 ± 0.3	49.8 ± 0.5	10.3 ± 0.3	42

* 4.2V Charge

** 4.1V Charge

CGR17500: Cylindrical Model

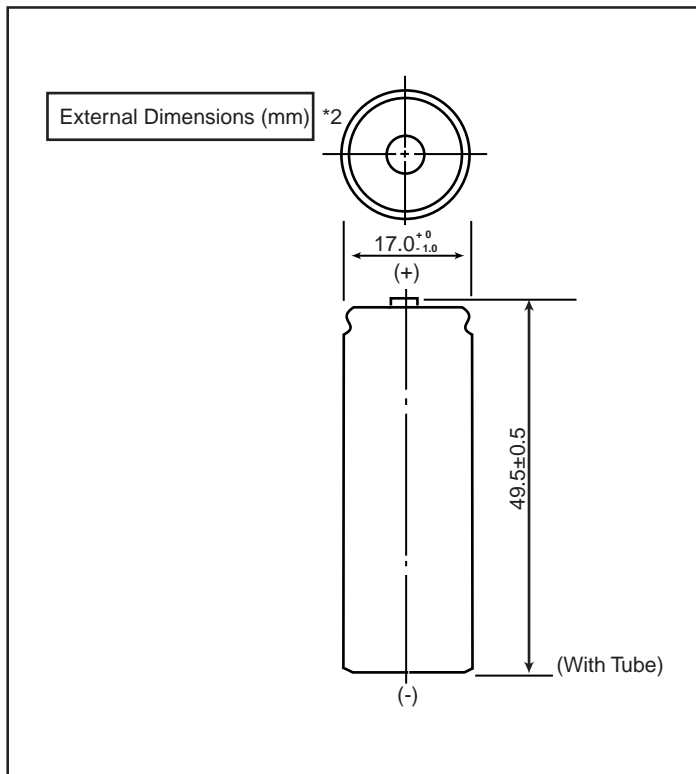

Specifications

Nominal Voltage		3.7V
Standard Capacity *1		830mAh
Dimensions*2	Diameter	17.0 ^{+0.10} _{-0.10} mm
	Height	49.5±0.5mm
	Weight	Approx. 25g

*1 After a fresh battery has been charged at constant voltage/constant current (4.2 V, 550 mA (max), 2 hours, 20°C), the average of the capacity (ending voltage of 3 V at 20°C) that is discharged at a standard current (156 mA).

*2 Dimensions of a fresh battery

Discharge Characteristics

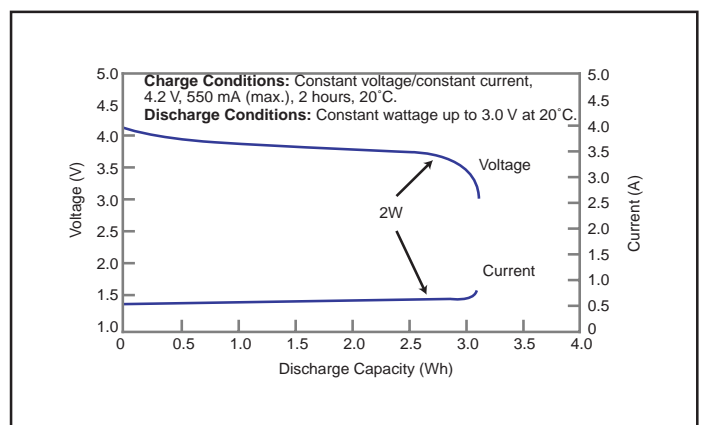
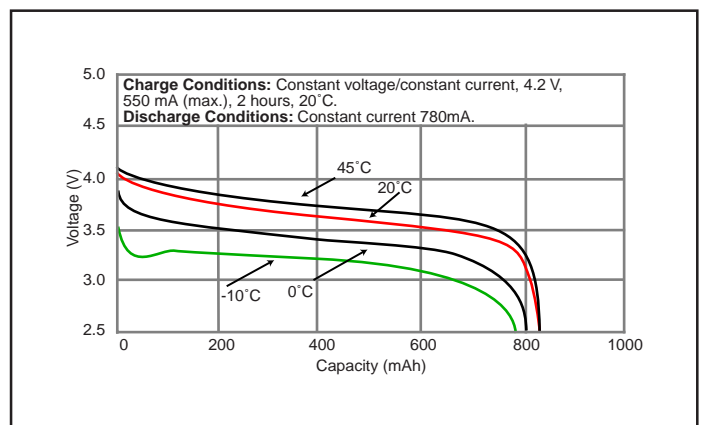
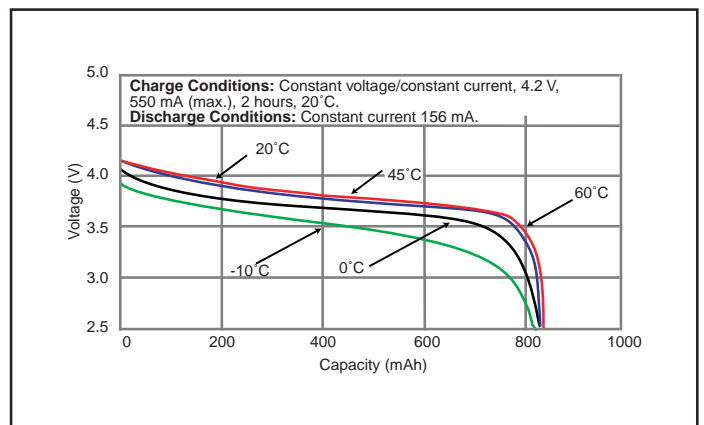
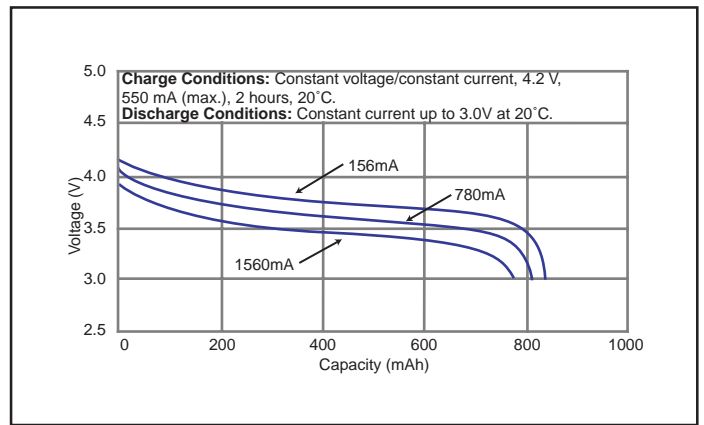

Discharge Characteristics

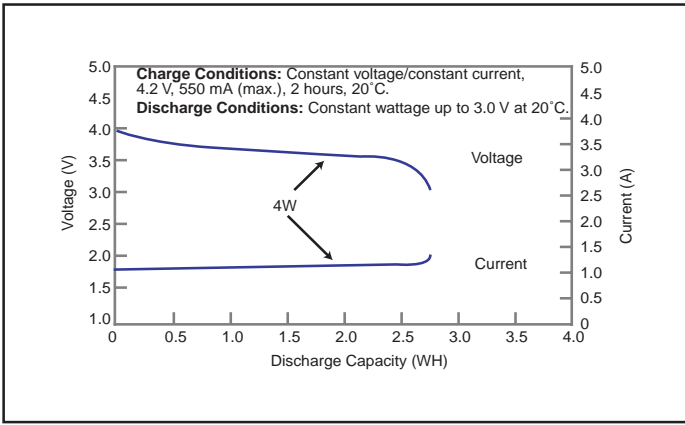

Storage Characteristics

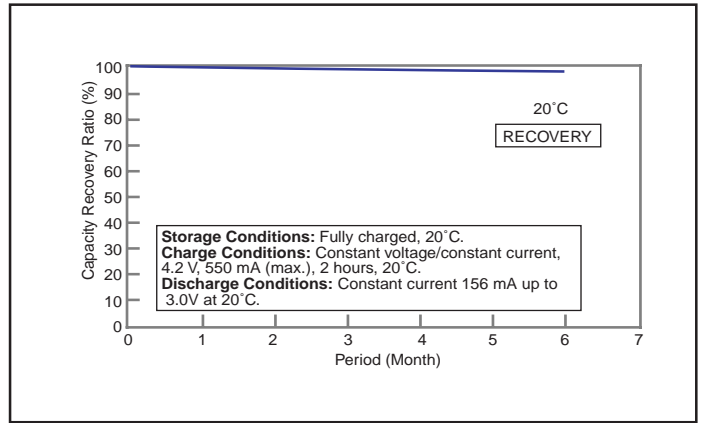
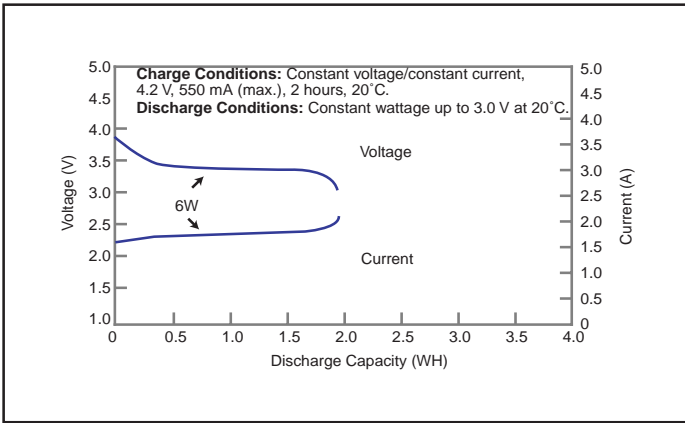
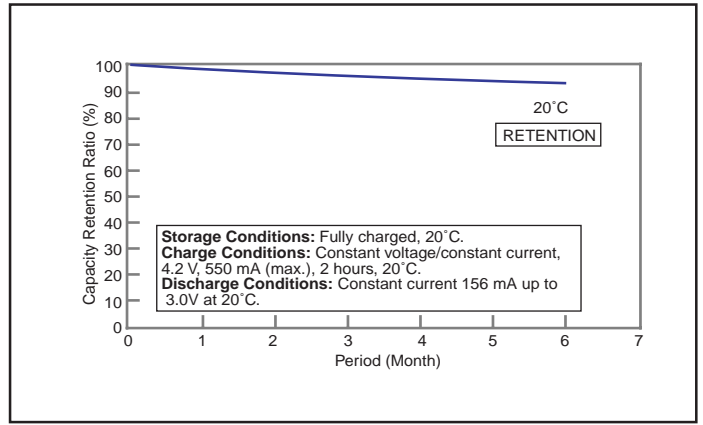

Charge Characteristics

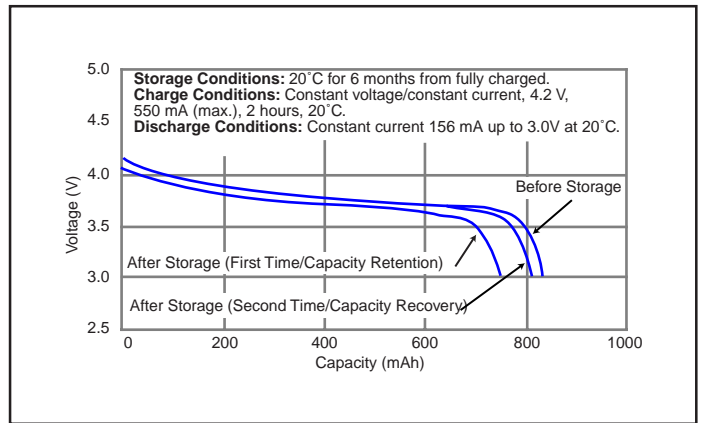
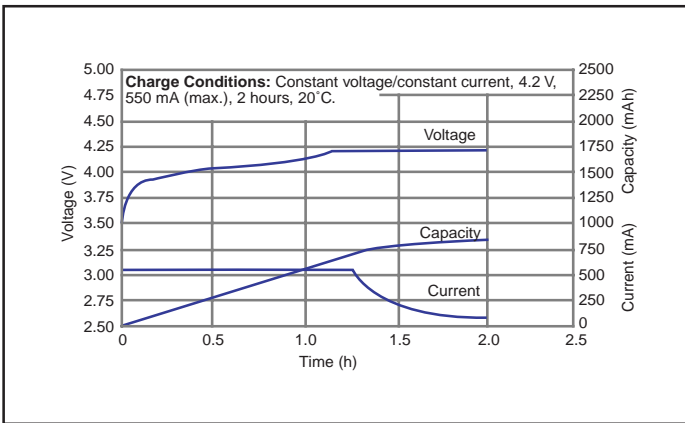

Cycle Life Characteristics

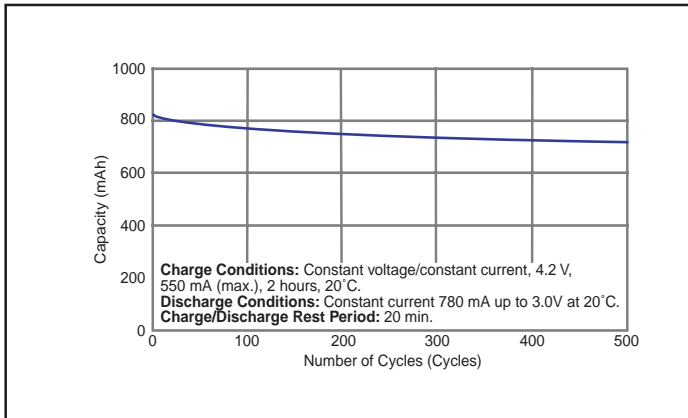

CGR17670HC: Cylindrical Model

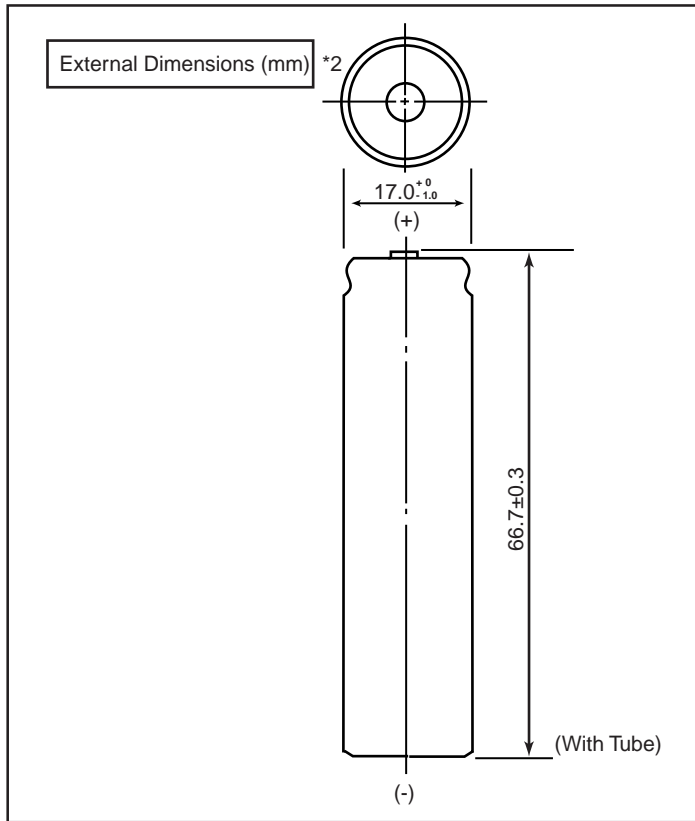

Specifications

Nominal Voltage		3.7V
Standard Capacity *1		1250mAh
Dimensions*2	Diameter	17.0 ^{+0/-0.1} mm
	Height	66.7±0.3mm
	Weight	Approx. 35g

*1 After a fresh battery has been charged at constant voltage/constant current (4.2 V, 840 mA (max), 2 hours, 20°C), the average of the capacity (ending voltage of 3 V at 20°C) that is discharged at a standard current (240 mA).

*2 Dimensions of a fresh battery

Discharge Characteristics

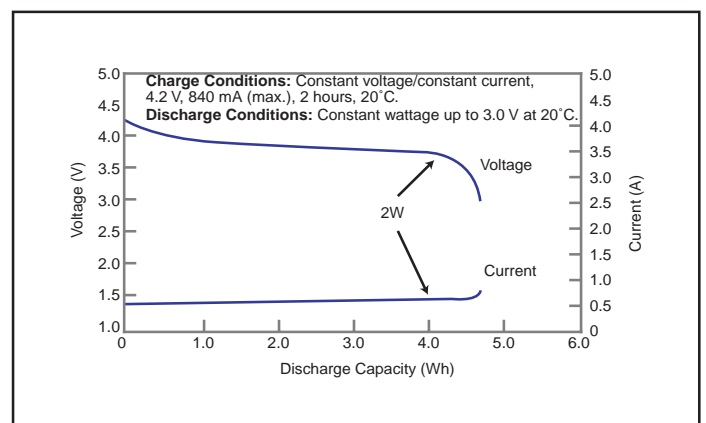
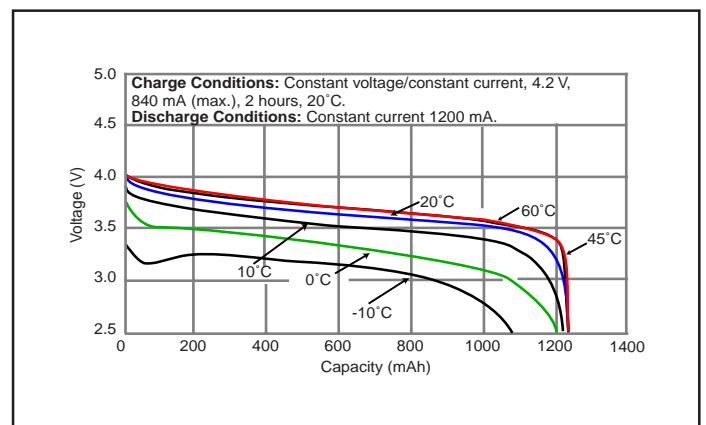
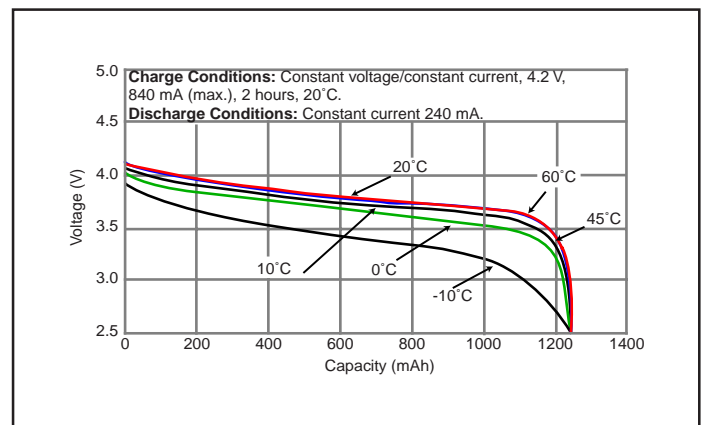
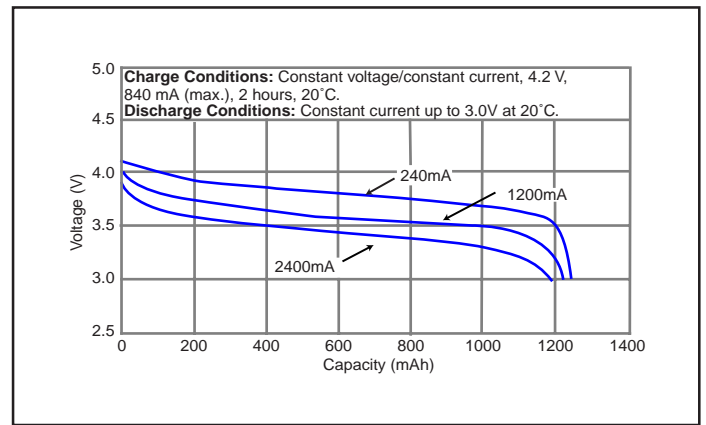

Discharge Characteristics

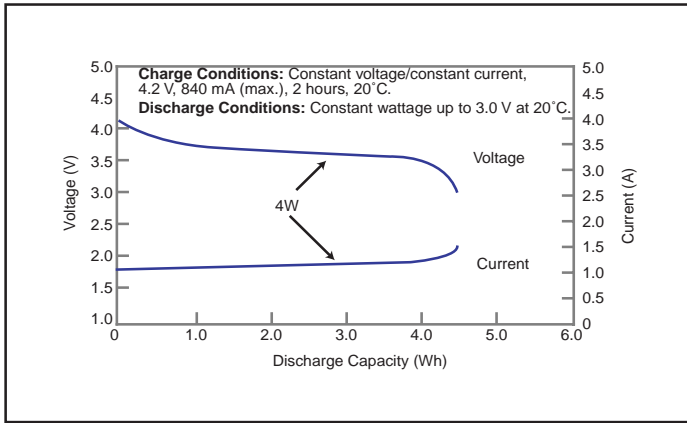

Storage Characteristics

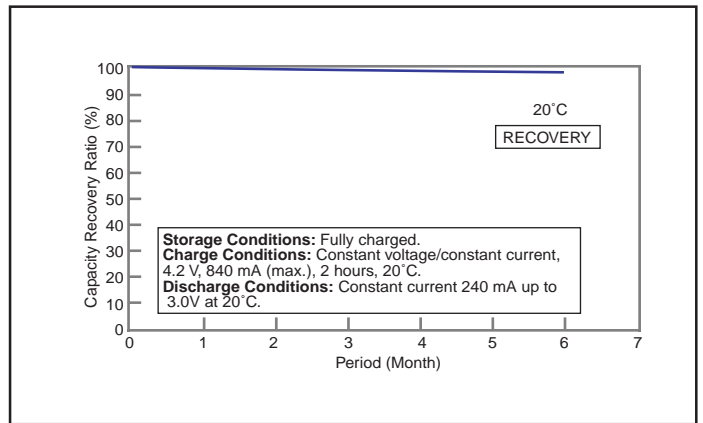
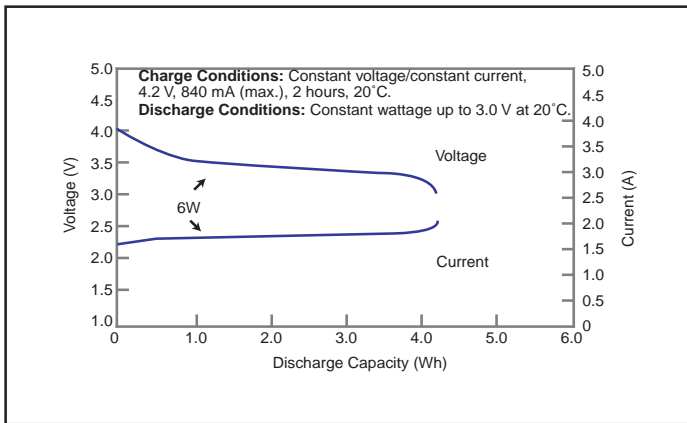
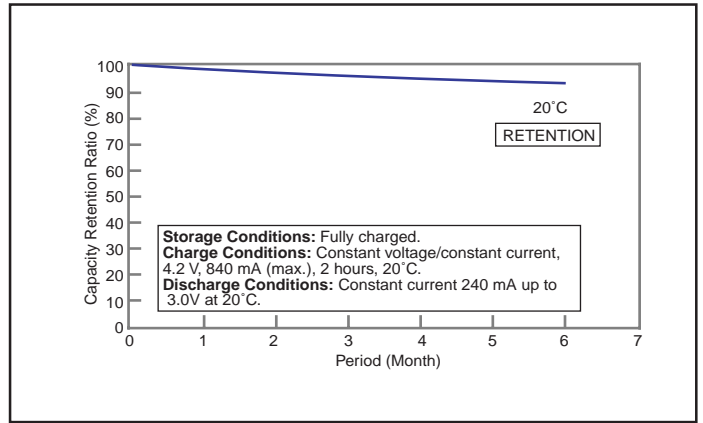

Charge Characteristics

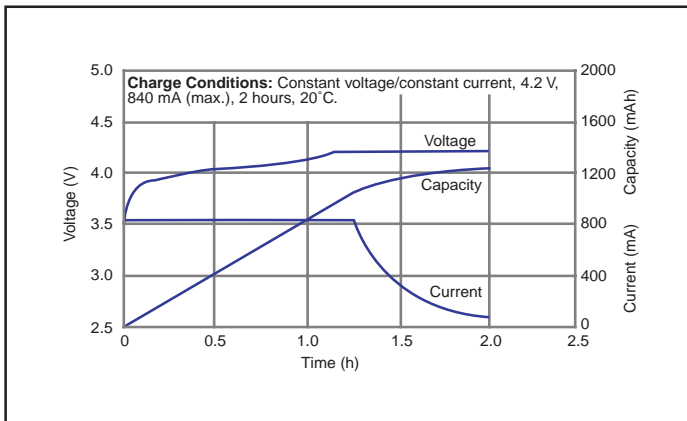

Cycle Life Characteristics

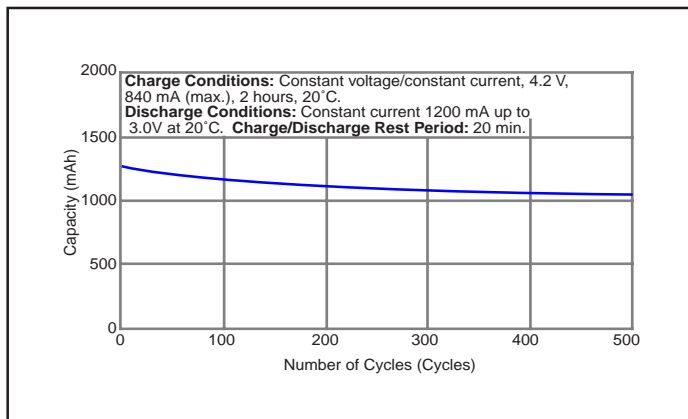

CGR18650H: Cylindrical Model

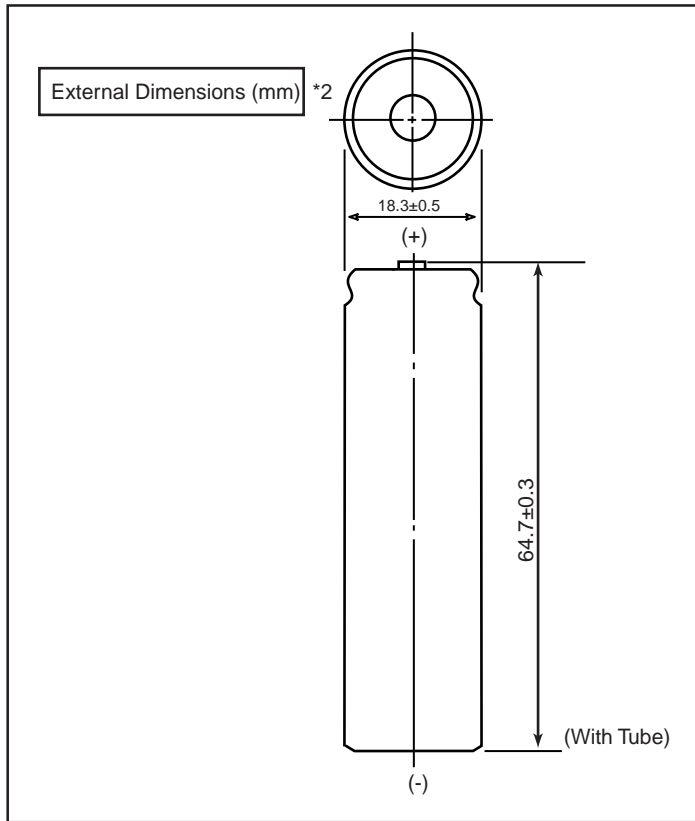

Specifications

Nominal Voltage		3.7V
Standard Capacity *1		1500mAh
Dimensions*2	Diameter	18.3±0.5mm
	Height	64.7±0.3mm
	Weight	Approx. 40g

*1 After a fresh battery has been charged at constant voltage/constant current (4.2 V, 980 mA (max), 2 hours, 20°C), the average of the capacity (ending voltage of 3 V at 20°C) that is discharged at a standard current (280 mA).

*2 Dimensions of a fresh battery

Discharge Characteristics

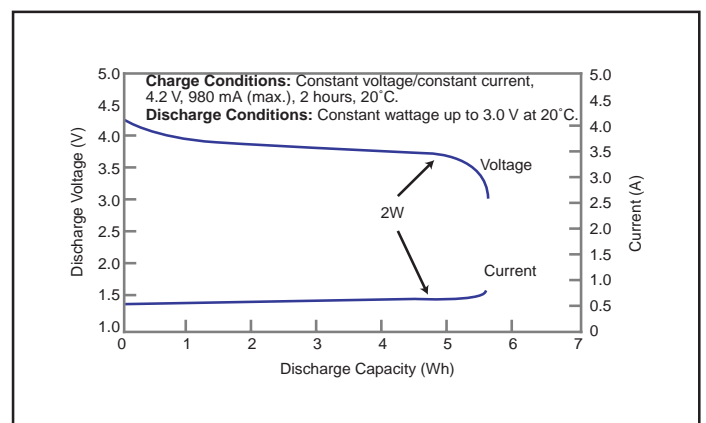
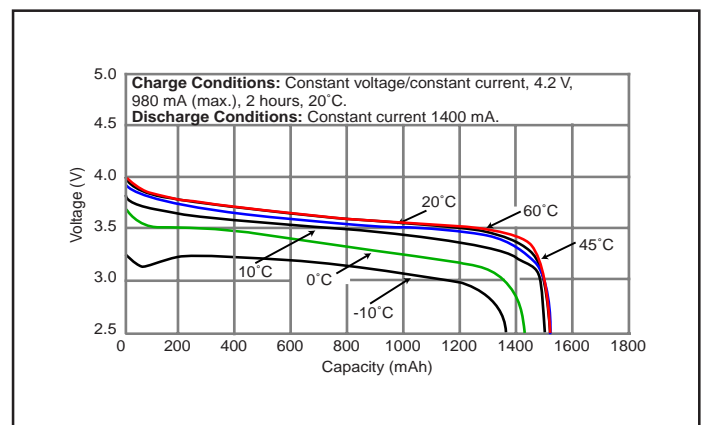
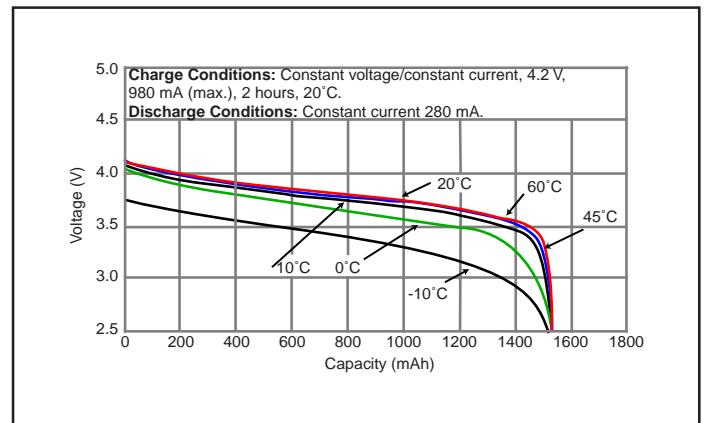
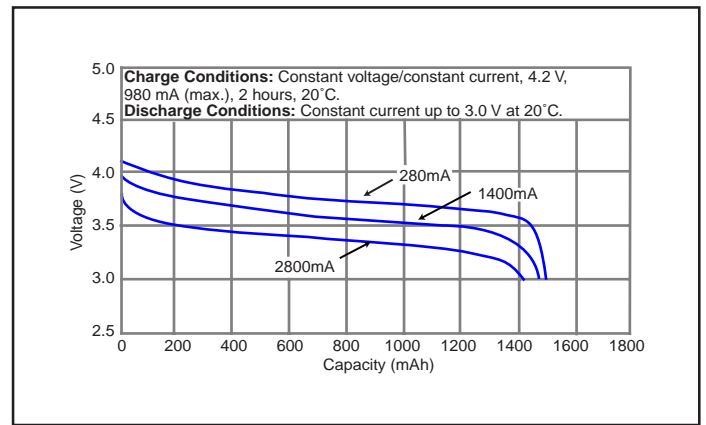

Discharge Characteristics

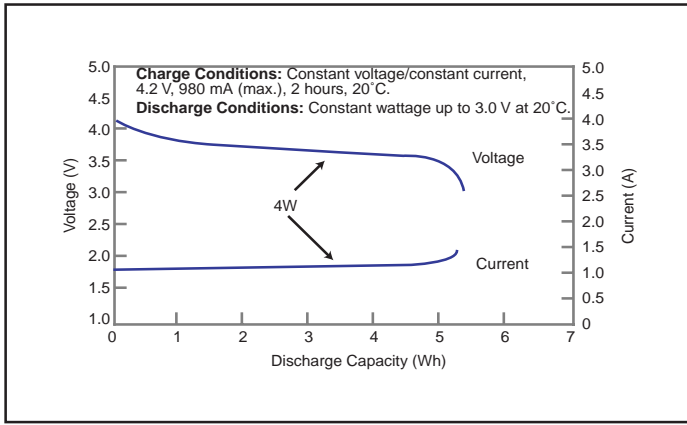

Storage Characteristics

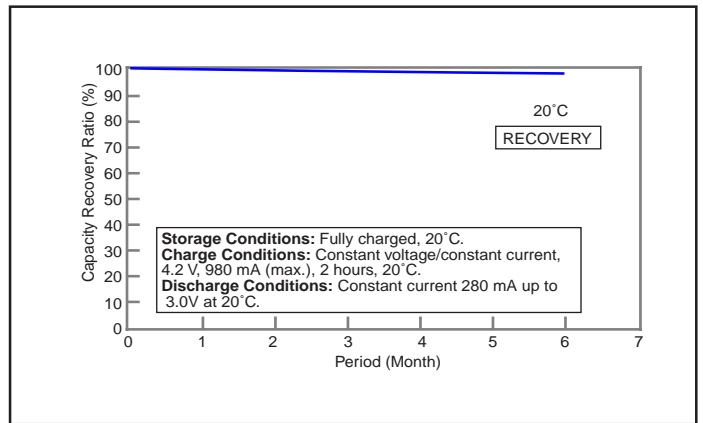
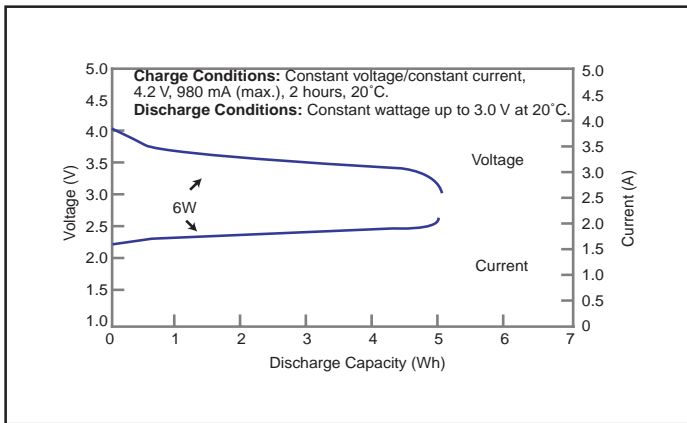
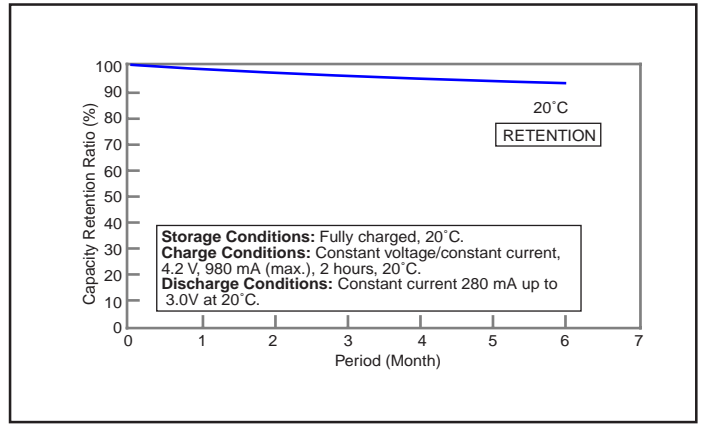

Charge Characteristics

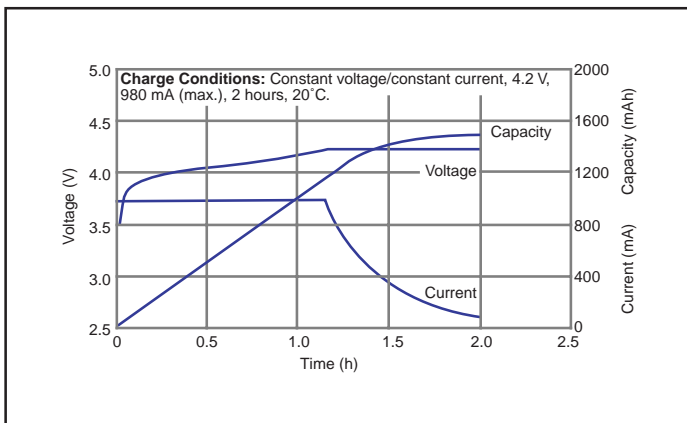

Cycle Life Characteristics

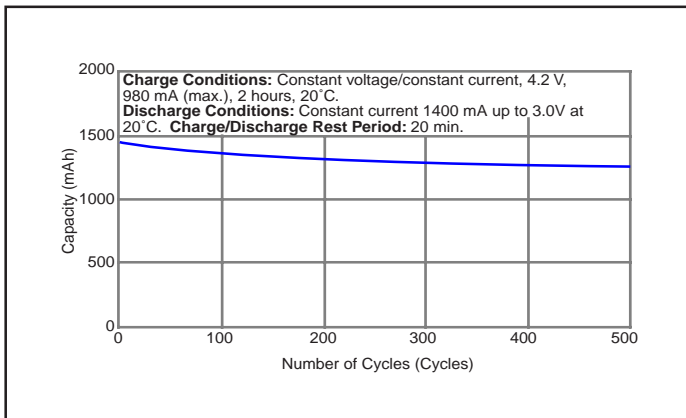

CGP30486: Prismatic Model

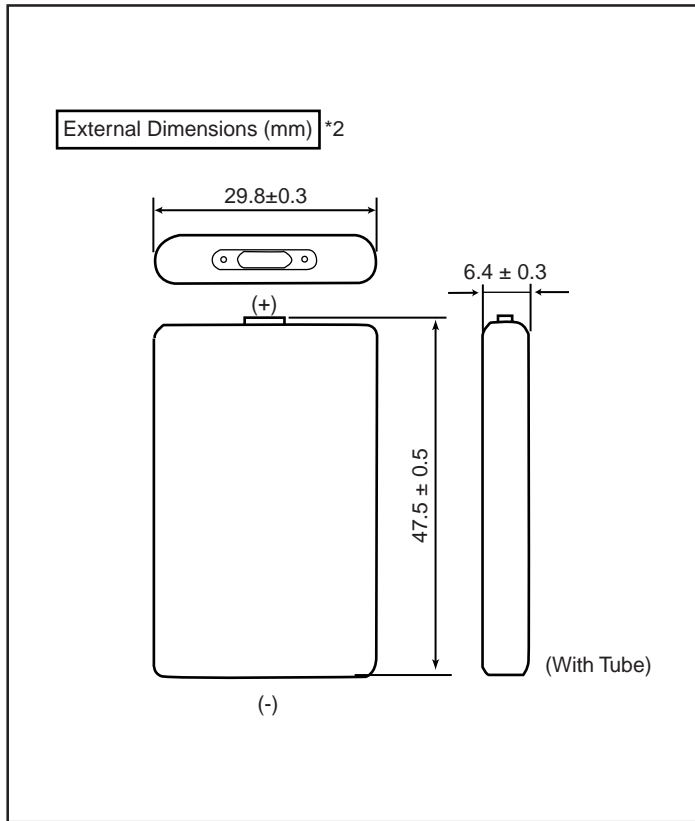

Specifications

Nominal Voltage		3.7V
Standard Capacity *1		630mAh
Dimensions*2	Width	29.8±0.3mm
	Height	47.5±0.5mm
	Thickness	6.4±0.3mm
	Weight	Approx. 23g

*1 After a fresh battery has been charged at constant voltage/constant current (4.1 V, 420 mA (max.), 2 hours, 20°C), the average of the capacity (ending voltage of 3 V at 20°C) that is discharged at a standard current (120 mA).

*2 Dimensions of a fresh battery

Discharge Characteristics

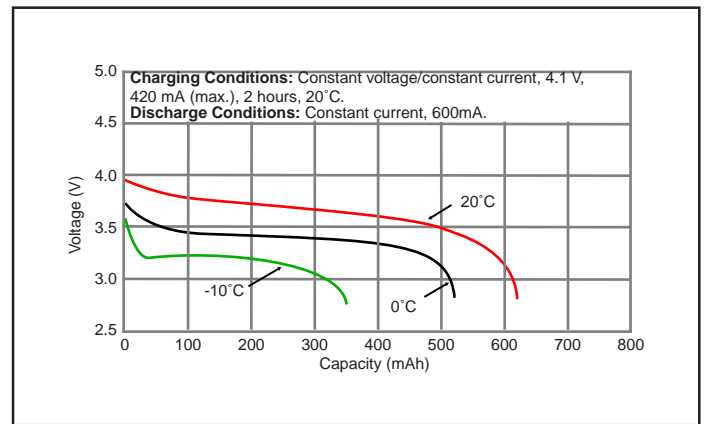
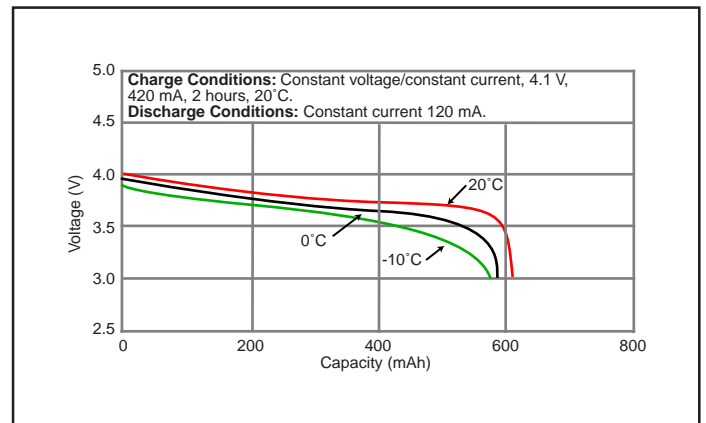
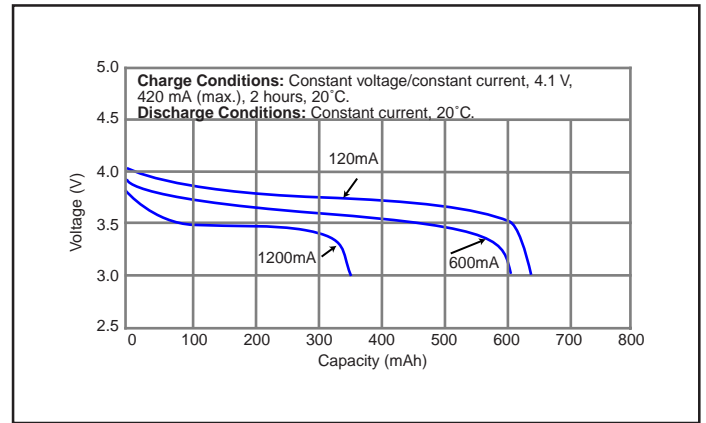

Charge Characteristics

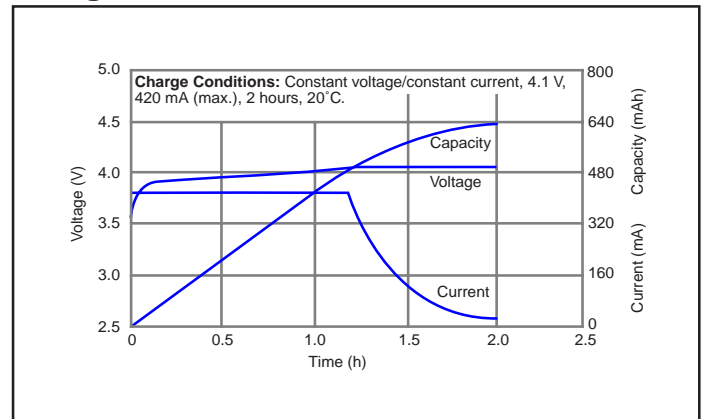

Cycle Life Characteristics

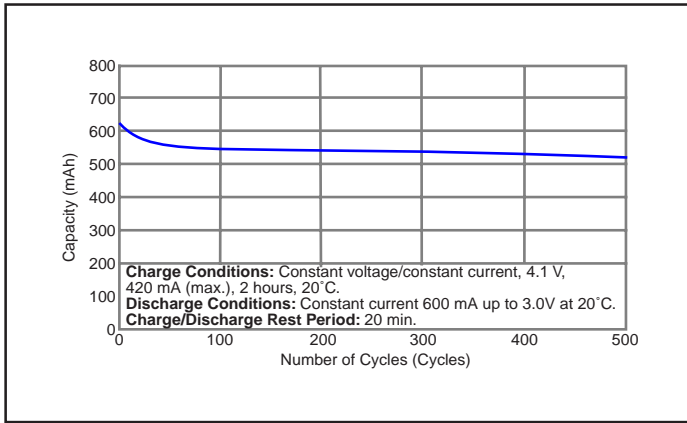

Storage Characteristics

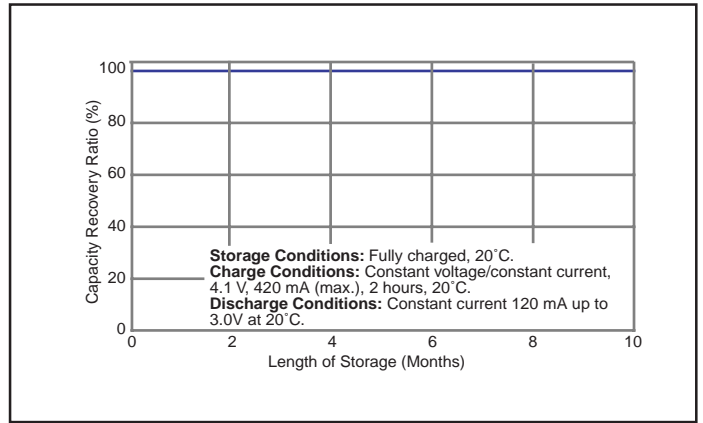

Storage Characteristics

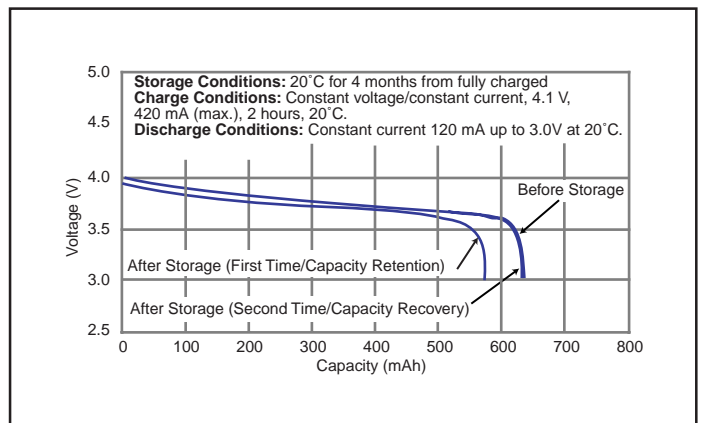
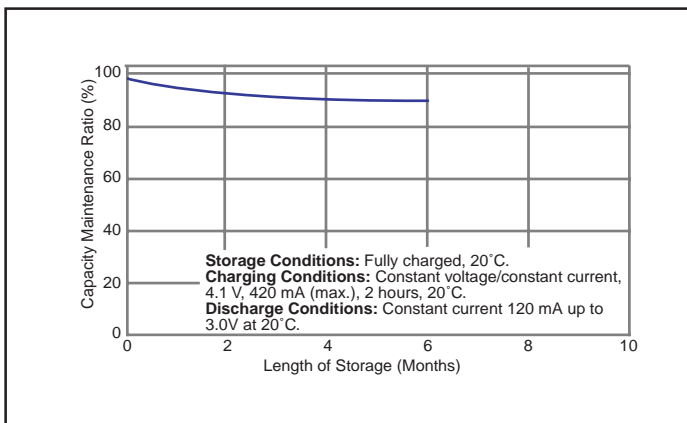

CGP345010: Prismatic Model

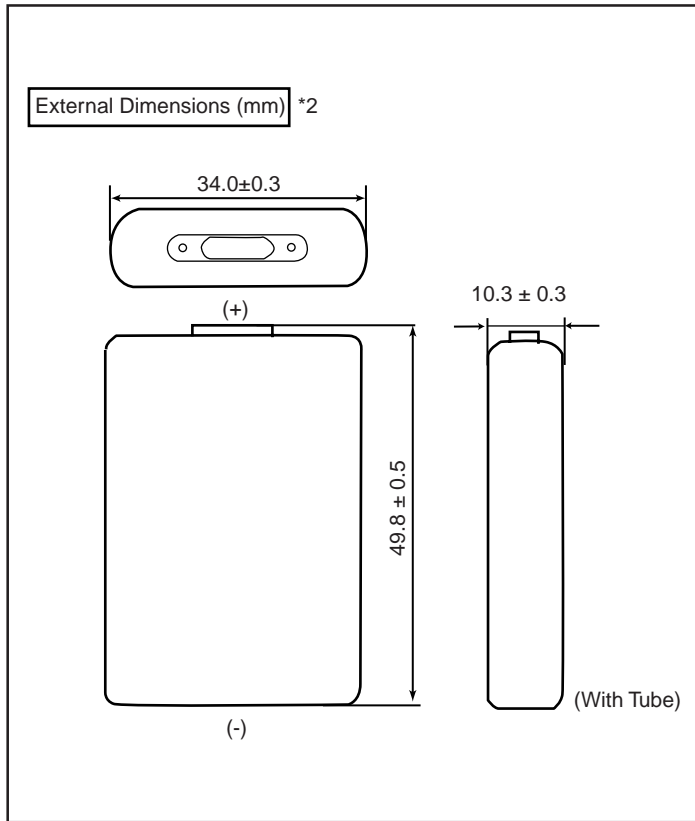

Specifications

Nominal Voltage		3.7V
Standard Capacity *1		1400mAh
Dimensions*2	Width	34.0±0.3mm
	Height	49.8±0.5mm
	Thickness	10.3±0.3mm
	Weight	Approx. 42g

*1 After a fresh battery has been charged at constant voltage/constant current (4.2 V, 945 mA (max), 2 hours, 20°C), the average of the capacity (ending voltage of 3 V at 20°C) that is discharged at a standard current (270 mA).

*2 Dimensions of a fresh battery

Discharge Characteristics

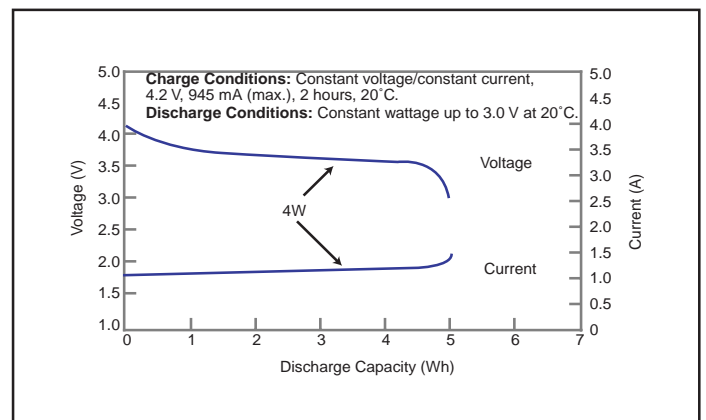
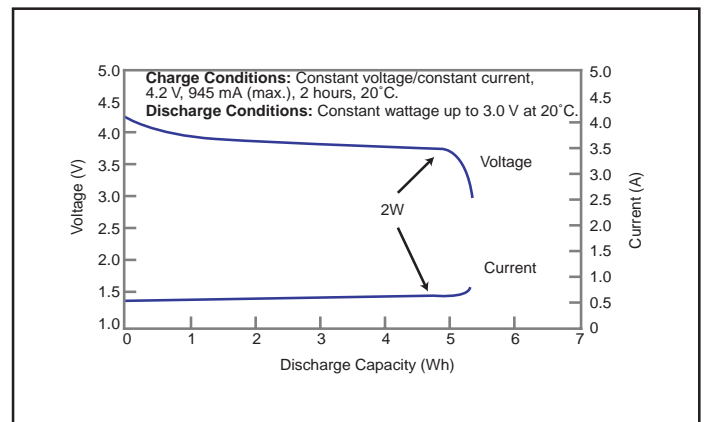
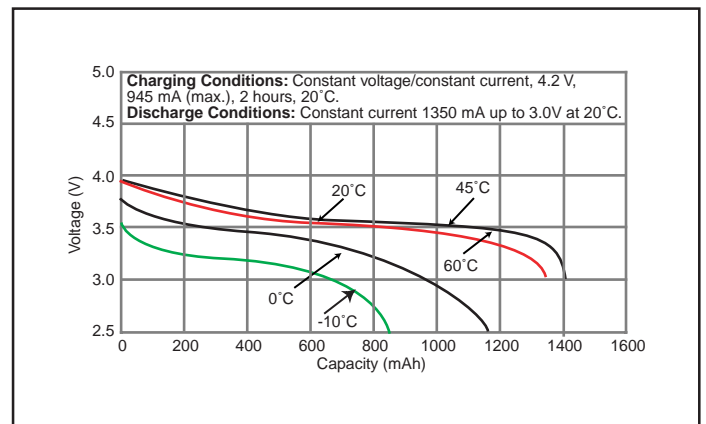
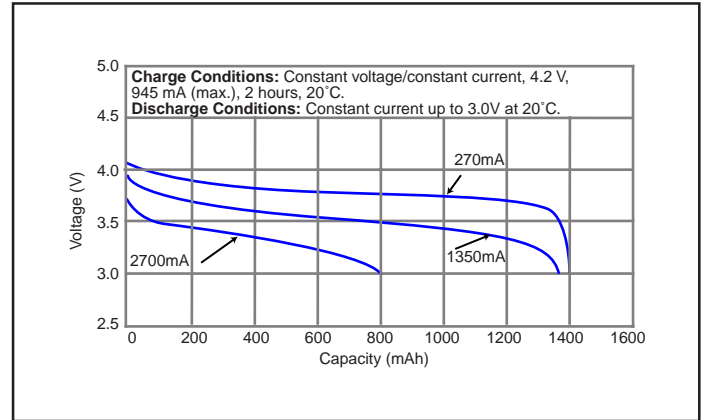

Discharge Characteristics

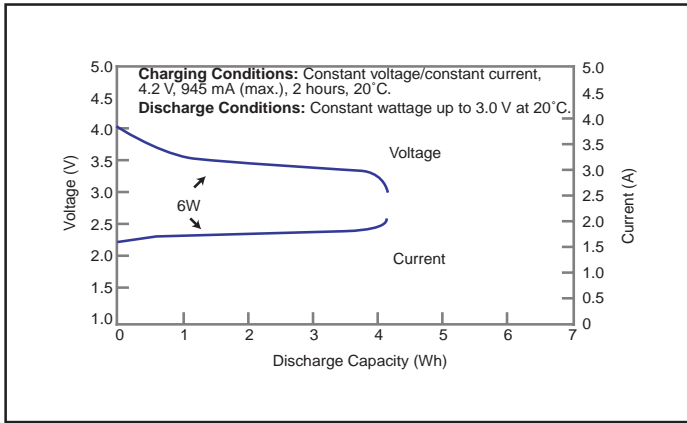

Cycle Life Characteristics

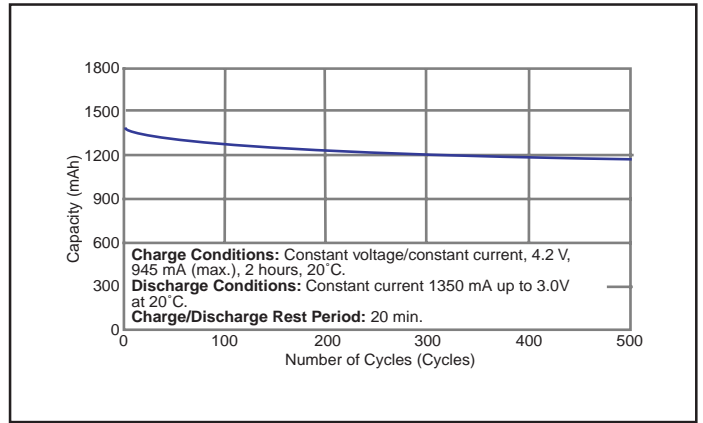

Charge Characteristics

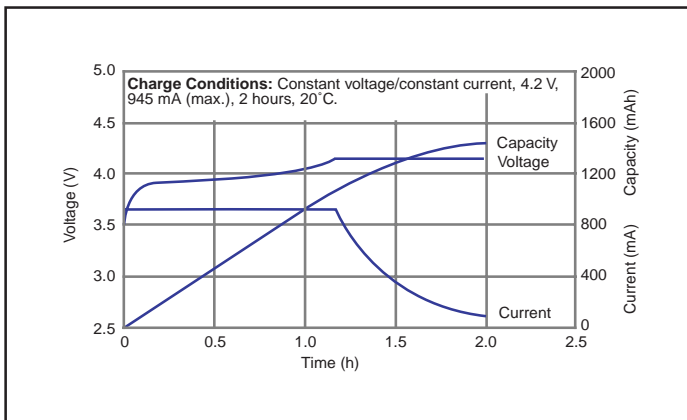

NEW
CGP34506: Prismatic Model

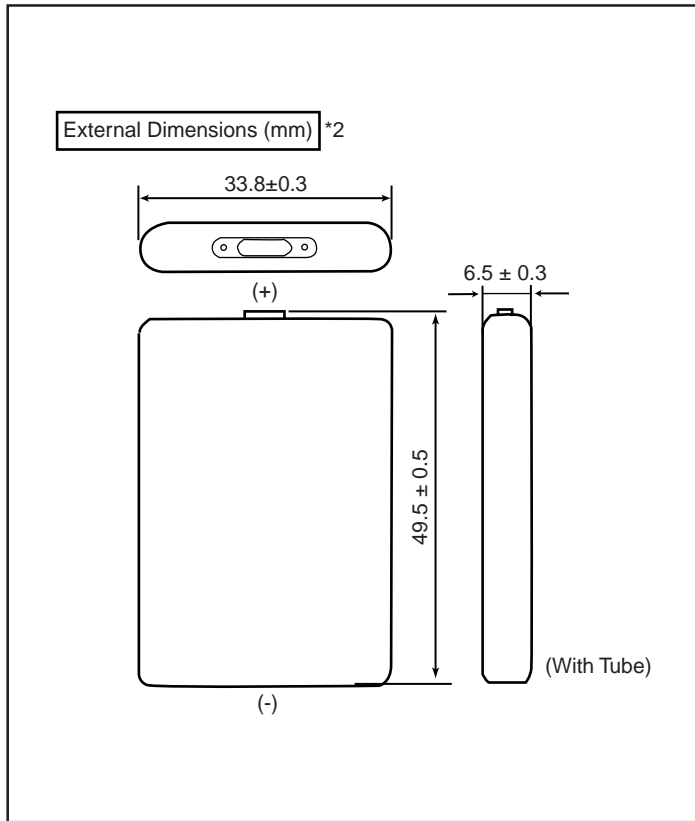

Specifications

Nominal Voltage		3.7V
Standard Capacity *1		875mAh
Dimensions*2	Width	33.8 ± 0.3mm
	Height	49.5 ± 0.5mm
	Thickness	6.5 ± 0.3mm
	Weight	Approx. 29g

*1 After a fresh battery has been charged at constant voltage/constant current (4.2 V, 600 mA (max.), 2 hours, 20°C), the average of the capacity (ending voltage of 3 V at 20°C) that is discharged at a standard current (170 mA).

*2 Dimensions of a fresh battery

Discharge Characteristics

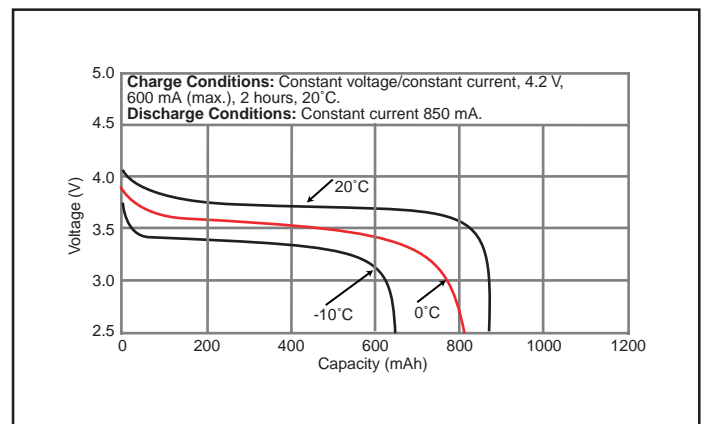
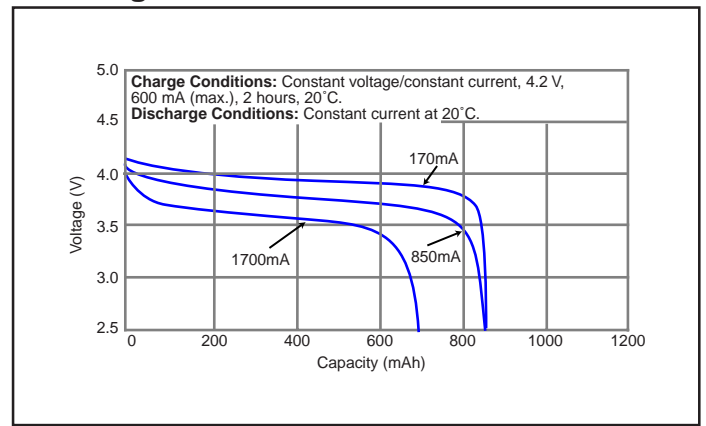

Charge Characteristics

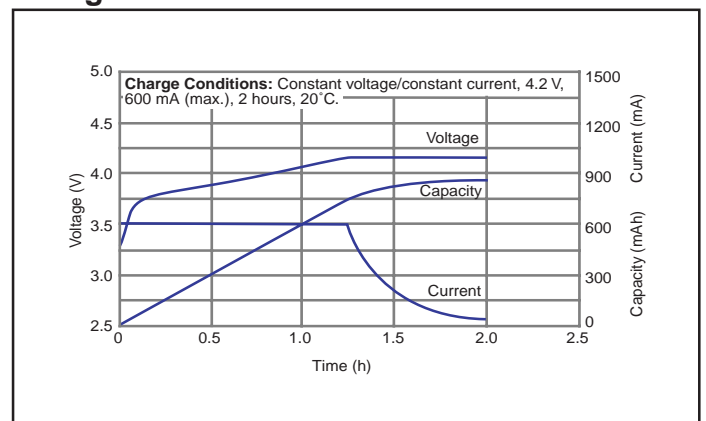

BATTERY PACK SPECIFICATION CHECKLIST

Battery Pack Specification Checklist

Fill in the blanks below to determine specifications when making inquiries or when ordering batteries.

1. Battery Pack: General

- 1) Schedule:
(1) Completion of design evaluation: Month: ____ Year: ____
(2) Completion of mass production evaluation: Month: ____ Year: ____
(3) Start of delivery: Month: ____ Year: ____
- 2) Number of units: ____ k packs per month (Total volume: ____ k packs)
- 3) Delivery Destination: (1) Domestic (2) Overseas (Name of country: ____)
- 4) Operating Temperature: (1) Standard (where the standard is 0°C to 45°C)
(2) Custom (____ °C to ____ °C)
- 5) Ambient Humidity: (1) Standard (where standard is 45 to 85%, non-condensing)
(2) Custom (____ % to ____ %)
- 6) Special Conditions for Use: (1) No (2) Yes ((1) Automotive (2) Outdoors (3) Other (____))
- 7) Applicable Specifications: (1) Electrical Appliance and Material Control Law (2) UL (3) Other (____)
- 8) Applicable Recipient: (1) Customer (2) Panasonic (3) Other (____)
- 9) Application: (1) Portable telephone (2) AV equipment (____)
(3) Personal computer (4) Other (____)
- 10) FG (Fuel Gauge) (1) Required (2) Not required (if required, fill in item 3)

2. Battery Pack Basic Specifications

- 1) Battery Pack Configuration: (1) Hard case (2) Soft pack (3) Other (____)
- 2) Battery Pack Materials: Specify (____)
- 3) Battery & Structure Used: 17500/17670HC/18650H/30486/345010/34506 (____ P x ____ S)
- 4) Rated Capacity: ____ mAh
- 5) Charging Method: (1) Fast (2) Standard (3) Other (____)
- 6) Charge Current: ____ A
- 7) Charge Time: ____ hours
- 8) Discharge Ending Voltage: ____ V
- 9) Thermistor: (1) Standard (Present/Absent) (Standard: 10 KW, 25°C) (2) Other (____)
- 10) Drop Strength: (1) Present (____ cm) (2) Absent
- 11) Flame Retardance Requirements: (1) Present (____) (2) Absent
- 12) Dimensions: ____ width x ____ length x ____ height mm or less
- 13) Weight: ____ g or less
- 14) Label: (1) Not required (2) Required (Details of label specified elsewhere.)
- 15) Terminal Configuration: (____)

3. Fuel Gauge Specifications

- 1) Range of load currents: (____ mA to ____ mA)
- 2) Load current waveform: (1) Wave height ____ mA (2) Conductive period ____ mSec
(3) Stop period ____ mSec
- 3) Accuracy: (1) ± 10% (2) ± 5% (3) Other (____)
- 4) Display method: (1) LED (2) Communications
(3) LED and communications (communications method ____)
- 5) Mode change (1) Not required (2) Required (Modes (suspend, etc.) (1) ____ (2) ____)
- 6) Communications data: (1) Remainder (2) Voltage (3) Current (4) Temperature
(5) ID code (6) Other (____)
- 7) Charge function (1) Not required (2) Required

CHARGER SPECIFICATION CHECKLIST

Charger Specification Checklist

Fill in the blanks below to determine specifications when making inquiries or when ordering.

1. General

- 1) Start of Delivery: Month: _____ Year: _____ Number of units: _____ per month
(Total volume: _____ units)
- 2) Delivery Destination: (1) Domestic (2) Overseas (Name of country: _____)
- 3) Operating Temperature: (1) Standard (where standard is 0°C to 45°C)
(2) Custom (_____°C to _____°C)
- 4) Ambient Humidity: (1) Standard (where standard is 45 to 85%, non-condensing)
(2) Custom (_____ % to _____ %)
- 5) Special Conditions for Use: (1) No (2) Yes ((1) Automotive (2) Outdoors (3) Other (_____))
- 6) Applicable Specifications: (1) Electrical Appliance and Material Control Law (2) UL (3) Other (_____)
- 7) Applicable Recipient: (1) Customer (2) Panasonic (3) Other (_____)
- 8) Application: (1) Portable telephone (2) AV equipment (_____)
(3) Personal computer (4) Other (_____)

2. Basic Specifications

- 1) Battery Pack Compatibility: 17500/17670HC/18650H/30486/345010/34506 (___P x ___S)
FG((1) Present (____) (2) Absent)
- 2) Charging Method: (1) Fast (2) Standard (3) Other (_____)
- 3) Charge Current: _____ A (Contact Panasonic regarding charging conditions.)
- 4) Charge Time: _____ hours
- 5) Charger Model: Pocket Type: 1 Unit 2 Units Other (_____)
- 6) Display LED: No. of Units: _____
- 7) Power Supply Voltage: _____ V/ _____ Hz (Range of Fluctuation: _____ V to _____ V/ _____ Hz to _____ Hz)
- 8) Drop strength: _____ cm
- 9) Dimensions: _____ width x _____ length x _____ height mm or less
- 10) Weight: _____ g or less
- 11) Label: (1) Not required (2) Required (Details of label _____)

